

FORD TRANSIT 130” WB – MID ROOF

Assembly Instructions

This document presents the detailed procedures for assembling Legend Fleet components and accessories. Customers can make use these step-by-step procedures and easily assemble without major difficulty.



LEGEND

FLEET SOLUTIONS

56957 HWY 3 WEST,
TILLSONBURG,
ON N4G 4G8.

Table of Contents

Wheel Well Cover	3
Parts and Hardware	3
Assembly Instructions.....	3
Floor.....	4
Parts and Hardware	4
Assembly Instructions.....	4
Floor Sills	7
Parts and Hardware	7
Assembly Instructions.....	7
Wall Liners	8
Parts and Hardware	8
Assembly Instructions.....	8
Ceiling Liners.....	10
Parts and Hardware	10
Assembly Instructions.....	10
Top Sills.....	12
Parts and Hardware	12
Assembly Instructions.....	12
Door Liners	15
Parts and Hardware	15
Assembly Instructions.....	15

Wheel Well Cover

Parts and Hardware

Parts List	Qty
Driver Side's Wheel Cover	1
Passenger side's Wheel well cover	1
Push- in Rivet	4



DRIVER SIDE'S WHEEL WELL COVER



PASSENGER SIDE'S WHEEL WELL COVER



PUSH - IN RIVET

Assembly Instructions

Floor and Wall liner must be installed after the installation of Wheel well covers

Step 1: Place the **Driver side** and **Passenger side** wheel well covers in the vehicle, as shown below.

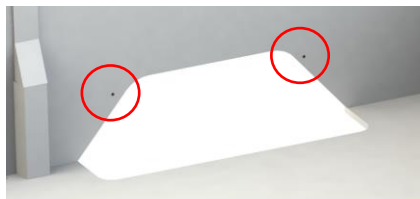

"Positioning of the Passenger side WWC"

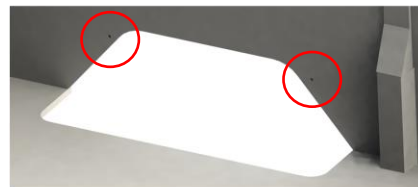

"Positioning of the Driver side WWC"



Floor

Parts and Hardware

Parts List	Qty	Parts List	Qty
Floor pieces	1 Each	Rear Rail Joint	1
Front Rail Joint	1	Glue Tube	1



FLOOR PIECES



FRONT RAIL JOINT



GLUE TUBE



REAR RAIL JOINT

Assembly Instructions

Remove the following items before floor installation:

1. OEM Plastic Trim
2. D-Rings
3. Tie-Downs
4. Other installed parts

Apply a thin line of glue in both the grooves of the Rail Joints, that is supplied with Legend's floor.

Step 1: Install Floor Piece A, as shown below.



Figure 1

Step 2: Install the Parts in the following order after installing Floor Piece A. as shown below.

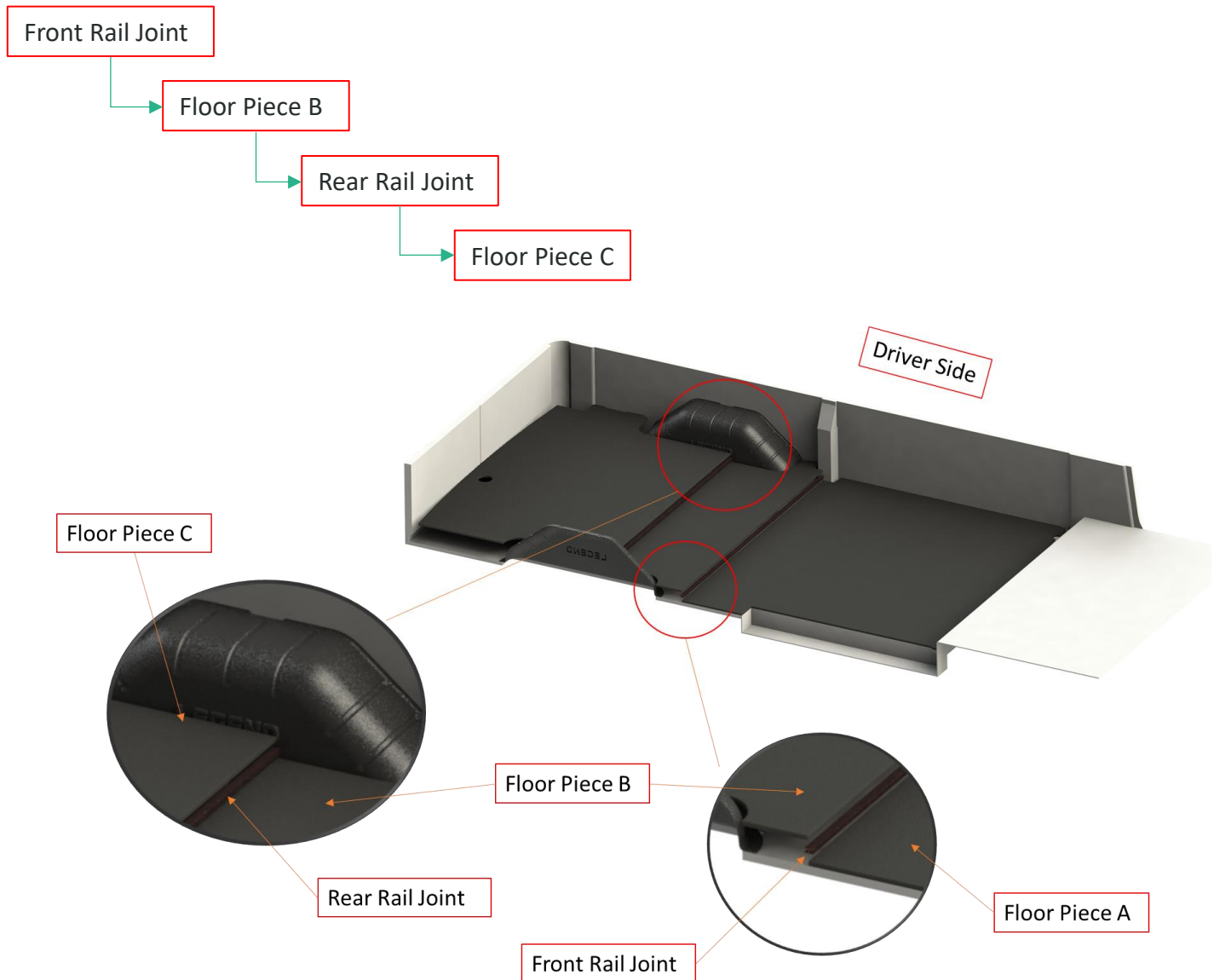

Figure 2

Step 3: Completing the installation of your Legend Floor

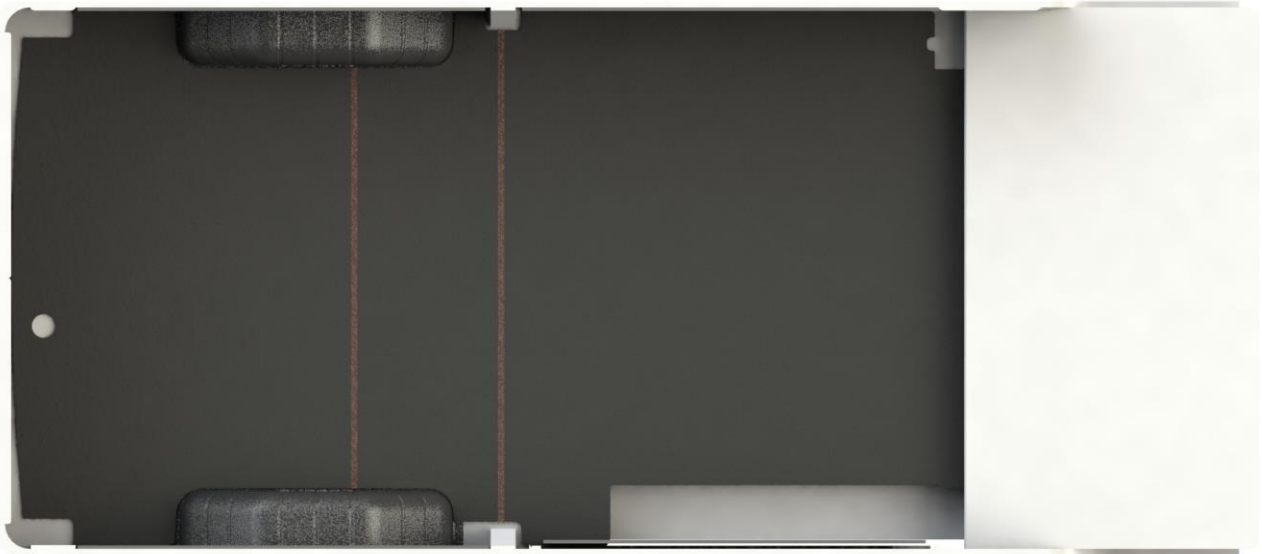

Figure 3

***"Floor Installed"** This view is from Inside of Van-Viewing from Top*

Floor Sills

Parts and Hardware

Parts List	Qty
Side Sill	1
Rear Sill	1
Pan – Head Screw	7

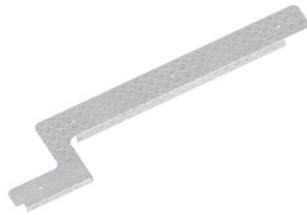

SIDE SILL



REAR SILL



PAN-HEAD SCREW

Assembly Instructions

Step 1: Position the Side Sill on Legend’s Floor. Place the Pan Head Screws (4 Nos) to the Floor as shown below

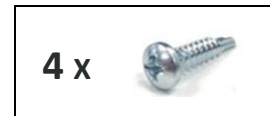
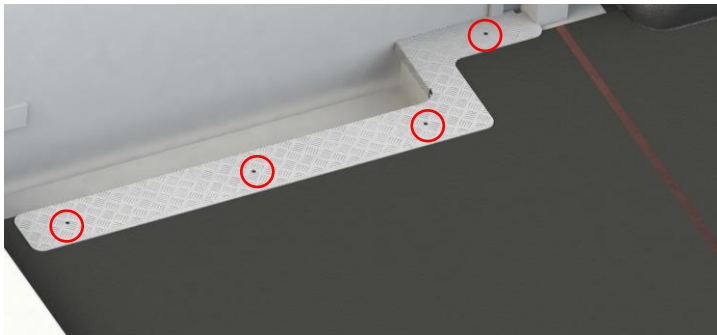

“Positioning and Fixing of the Side Sill”

Step 2: Position the Rear Sill on Legend’s Floor.

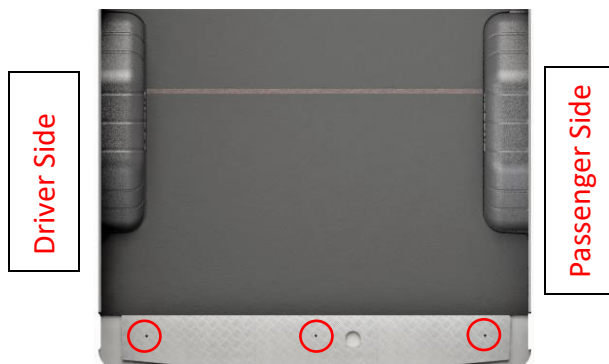

Figure 5

“Positioning and Fixing of the Rear Sill”

Wall Liners

Parts and Hardware

Parts List	Qty	Parts List	Qty
Driver Side Front Wall	1	Passenger Side Rear Wall	1
Driver Side Rear Wall	1	Push-In Rivet	72



DRIVER SIDE FRONT WALL



DRIVER SIDE REAR WALL

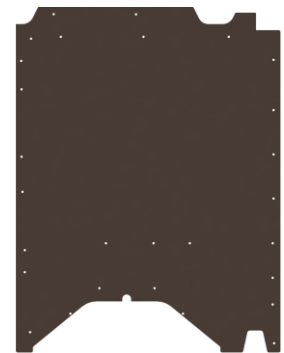

PASSENGER SIDE REAR WALL



PUSH-IN RIVET

Assembly Instructions

If Legend's Wheel Well Covers are used, the Wall Liner will lay over the Top Flange of Wheel Well Cover.

Hole Diameter (\varnothing) = 0.40" = 

Step 1: Bring the (D1A) Liner into the vehicle and align the holes on the panel with the ones present on the vehicle's body.



Figure 6

Step 2: Bring the (D2A) Liner into the vehicle and align the holes on the panel with the ones present on the vehicle's body.

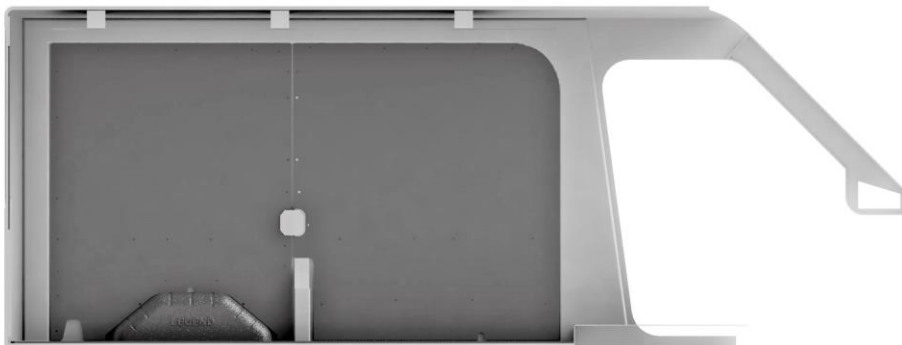

Figure 7

"Driver & Rear Side Front Wall Liner Installed" This is view from Inside of the Van- Viewing from Passenger Side

Step 3: Bring the (P1A) Liner into the vehicle and align the holes on the panel with the ones present on the vehicle's body.

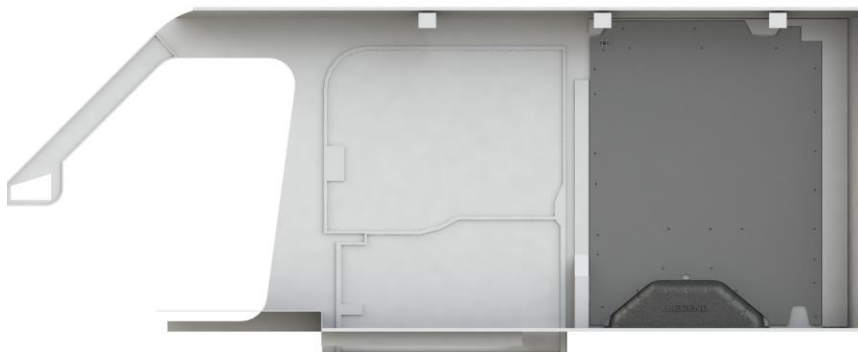

Figure 8

"Passenger Side Wall Liner Installed" This is view from Inside of the Van- Viewing from Driver Side

Step 4: Installation of your Legend Wall Liners is now complete.

Ceiling Liners

Parts and Hardware

Parts List	Qty
Ceiling Liner	1
Push-In Rivet	12



CEILING LINER



PUSH-IN RIVET

Assembly Instructions

Follow the below instructions for score lines on Rear surface of Ceiling Panel

Cut along this score line (Shown in Green) if Foam Blocks are present behind headliner

Cut along this score line (Shown in Red) to fit around the OEM Lights

Bend the Panel along this score line (Shown in Blue) to allow the ceiling to arch along the cross beam

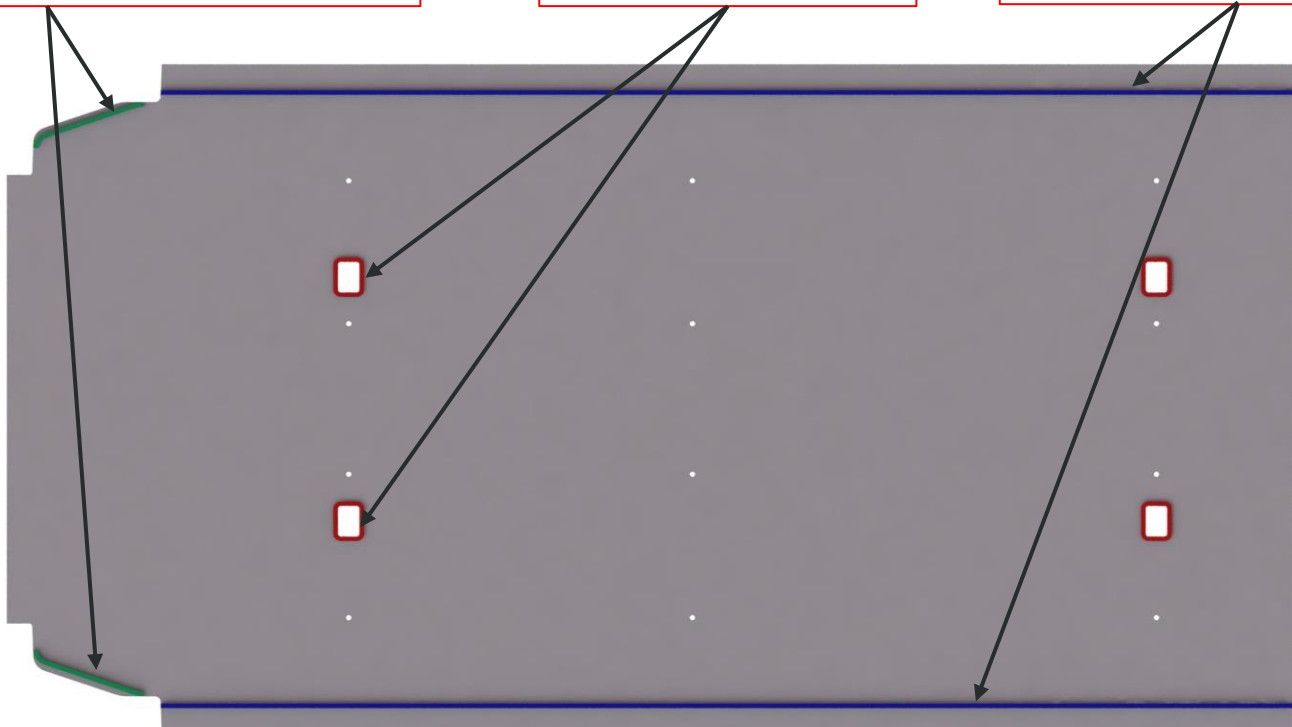

Step 1: Install Ceiling Panel, as shown below. Ceiling liner.



Figure 9

"Positioning and Fixing of the Ceiling Panel" This View is from Inside of the Van

Step 2: This completes the installation of your Legend Ceiling Liner

Top Sills

Parts and Hardware

Parts List	Qty	Parts List	Qty
Two Piece Driver Side Sill	1 Each	Top Sill Joiner	2
Two Piece Passenger Side Sill	1 Each	Pan - Head Screw	32



Sill C



Sill B



Sill D



Sill A

TWO PIECE DRIVER SIDE SILL

TWO PIECE PASSENGER SIDE SILL



TOP SILL JOINER



PAN-HEAD SCREW

Assembly Instructions

Assembly of the Top Sills is to be done outside of the Van before installing it in the Van.

Step 1: Assemble Driver Side sill – C, D, as shown below.

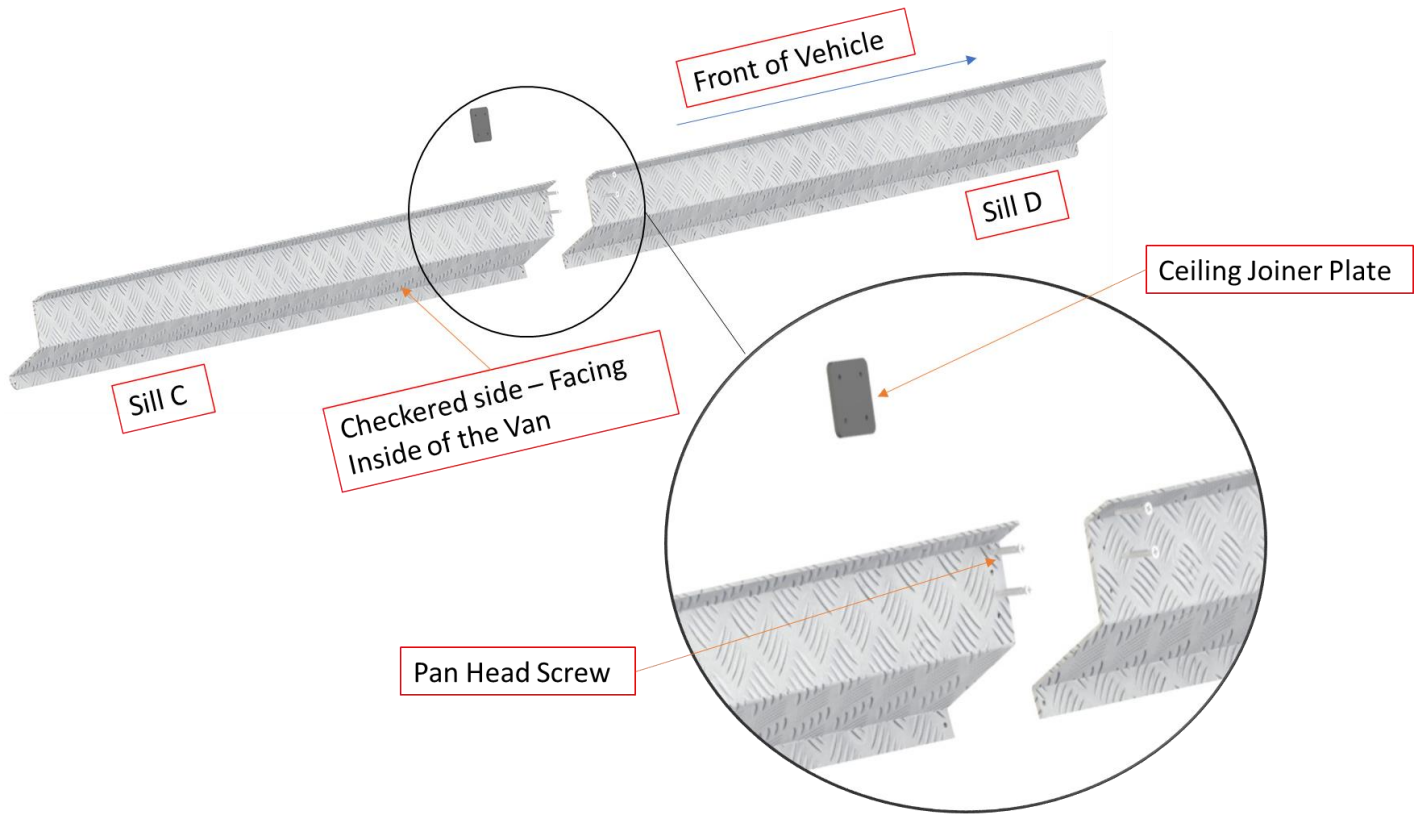

Figure 10

Step 2: Fasten assembled sills in the Van.

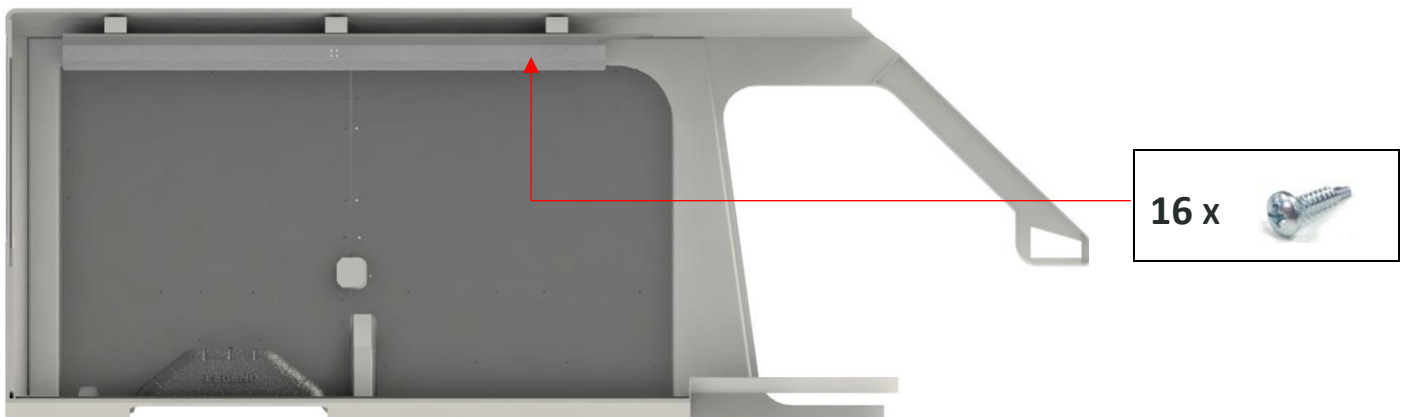

Figure 11
"Driver side Top Sills installed"

Step 3: Assemble Passenger Side Sill – A, B, as shown below.

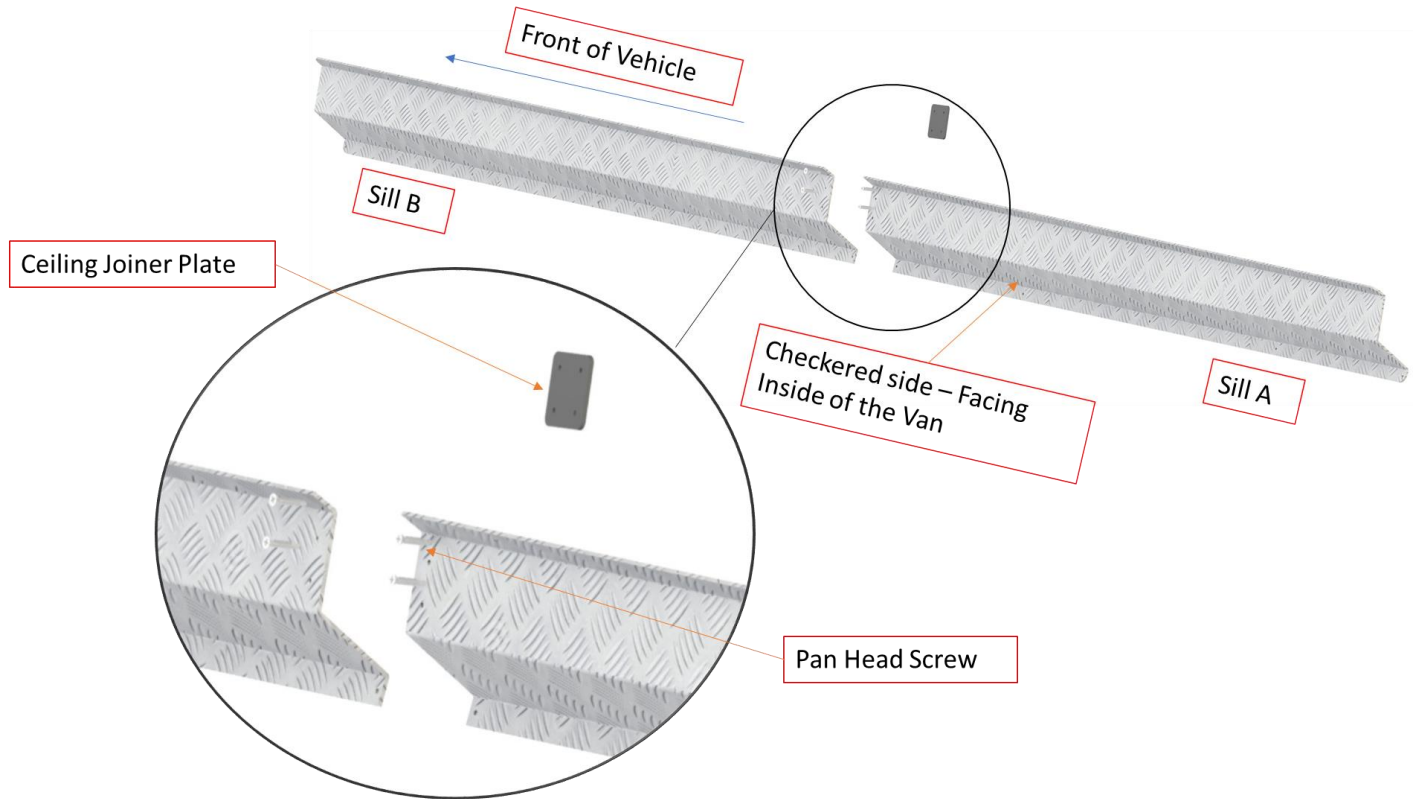

Figure 12

Step 4: Fasten assembled sills in the Van.

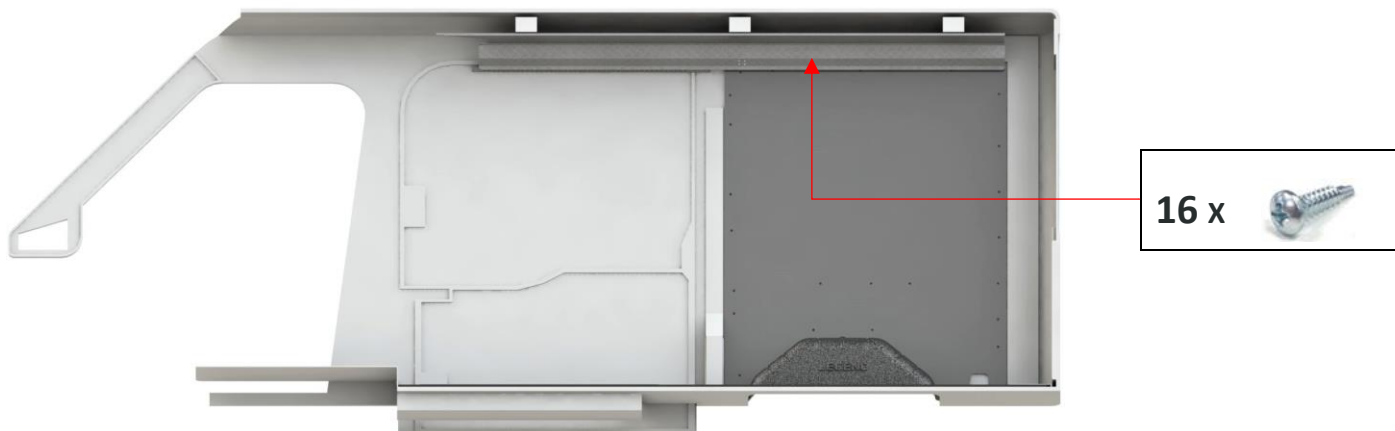
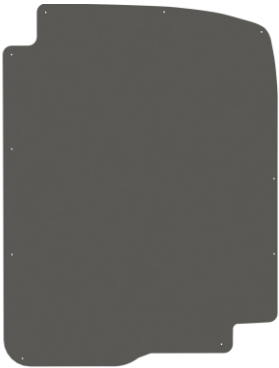

Figure 13
 "Passenger side Top Sills installed"

Door Liners

Parts and Hardware

Parts List	Qty	Parts List	Qty
Driver Side Rear Door Liner	1	Push-In Rivet	10
Passenger Side Rear Door Liner	1	Screw Cap	30
Passenger Side Sliding Door Liner 1 - 2	1 Each	Self-Tapping Screw	30



DRIVER SIDE REAR DOOR LINER



PASSENGER SIDE REAR DOOR LINER

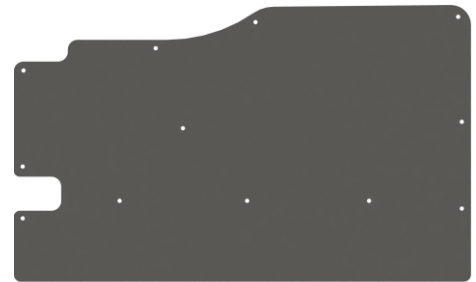

PASSENGER SIDE SLIDING DOOR LINER 1



PASSENGER SIDE SLIDING DOOR LINER 2



SCREW CAP



SELF- TAPPING SCREW



PUSH-IN RIVET

Assembly Instructions

Van Doors *MUST* be in close Position When Installing Door Liners.

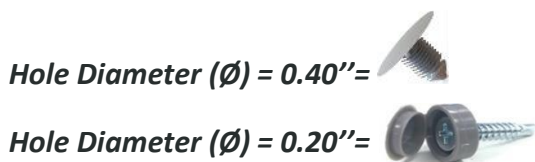

Step 1: Rear Door Assembly.

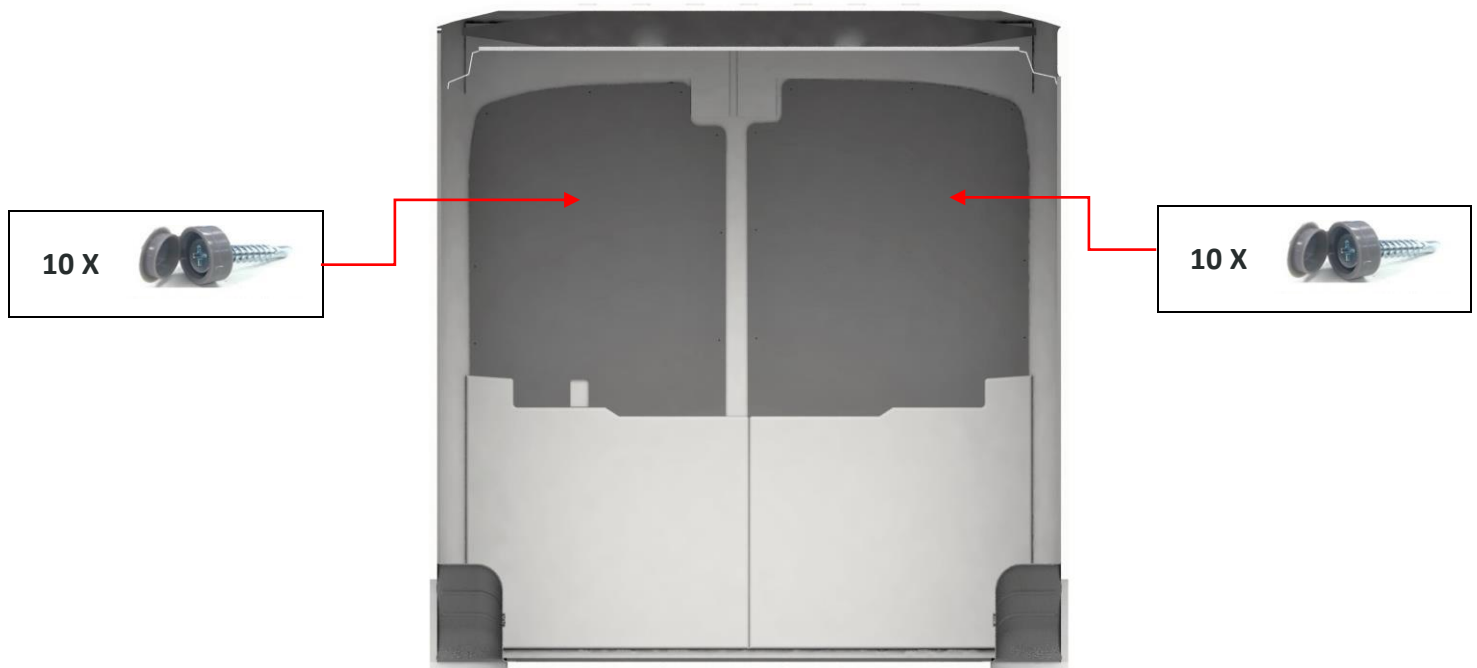

Figure 14

Step 2: Side Door Assembly.

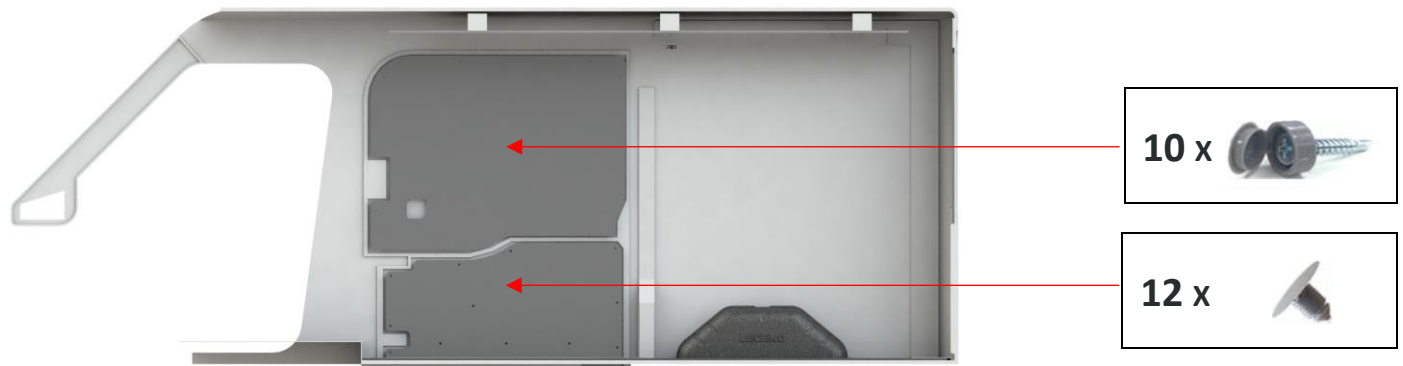

Figure 15

"Passenger Side Sliding Door Liner Installed"

Step 3: Installation of your Legend Door Liners is now complete.

Location of Spacer Foam Ford Transit Cargo Vans

Towards front of the vehicle
→

