

# LEGEND FLEET SOLUTIONS

## NISSAN NV LOW ROOF WALL LINERS

### INSTALLATION INSTRUCTIONS



#### NOTES:

1. Before commencing, remove all wall liners and “D” Rings already installed in the vehicle.
2. Consult layout PDF and compare vehicle layout allocated Legend.
3. Prepare hardware shown below and have them ready for installation.
4. Wall liners will be installed in the order shown in the instructions.
5. A drill with a Phillips driver is required to install hardware ( C ) #8 Screws, shown below.
6. Reinstall all “D” Rings once the wall liner kit installation is completed.

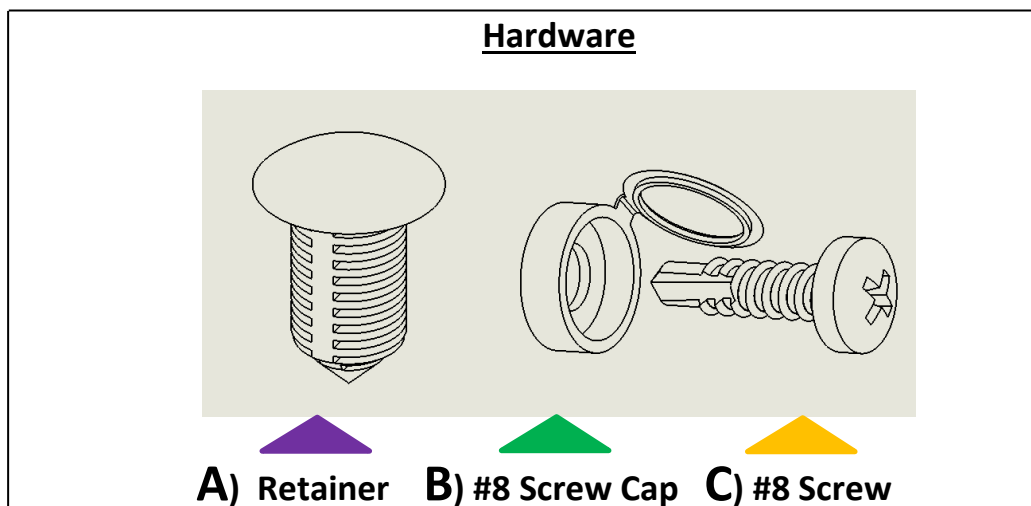

# NISSAN NV LOW ROOF WALL LINERS

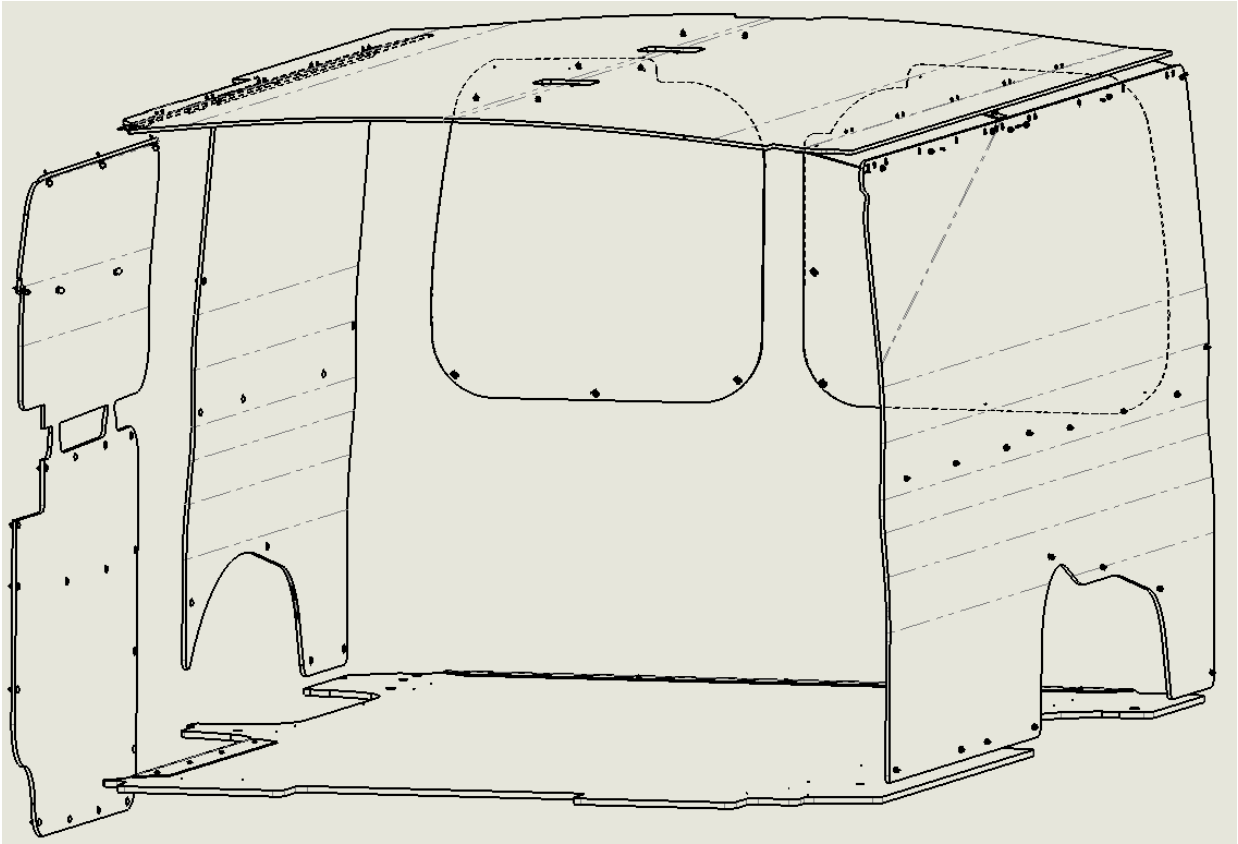

**BOM Table**

| ITEM NO. | PART NUMBER  | DESCRIPTION                                      | QTY. |
|----------|--------------|--|------|
| 1        | 513-114-2613 | GREY SLIDING DOOR PANEL NISSAN NV LR             | 1    |
| 2        | 512-xxx-6641 | FLOOR NISSAN NV                                  | 1    |
| 3        | 524-114-2613 | GREY WALL PANEL DRIVER SIDE NISSAN NV            | 1    |
| 4        | 515-114-2613 | GREY CEILING PANEL NISSAN NV LR                  | 1    |
| 5        | SCREW CAP    | SCREW CAP  | 20   |
| 6        | SCREW        | SCREW - PHIL. PAN HD #8X.75 SELF DRILLING        | 71   |
| 7        | 513-114-2613 | GREY REAR DOOR PANEL DRIVER SIDE NISSAN NV LR    | 1    |
| 8        | 513-114-2613 | GREY REAR DOOR PANEL PASSENGER SIDE NISSAN NV LR | 1    |
| 9        | 524-114-2613 | GREY REAR PANEL PASSENGER SIDE NISSAN NV         | 1    |
| 10       | 517-151-1010 | CEILING SILL "C" NISSAN NV LR                    | 1    |
| 11       | 517-151-1010 | CEILING SILL "A" NISSAN NV LR                    | 1    |
| 12       | 517-151-1010 | CEILING SILL JOINER PLATE                        | 2    |
| 13       | 517-151-1010 | CEILING SILL "B" NISSAN NV                       | 1    |
| 14       | 517-151-1010 | CEILING SILL "D" NISSAN NV LR                    | 1    |
| 15       | RETAINER     | RETAINER- BLACK NYLON                            | 57   |
| 16       | 008-151-1010 | FLOOR SILL REAR DOOR NISSAN NV                   | 1    |
| 17       | 006-151-1010 | FLOOR SILL SIDE DOOR NISSAN NV                   | 1    |

Note:

Model may differ depending if the vehicle was purchased with an OEM partition or not.

## Driver Side Wall Liner Installation

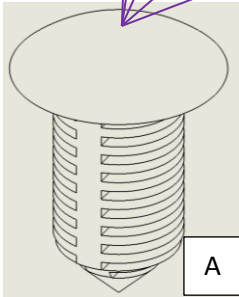
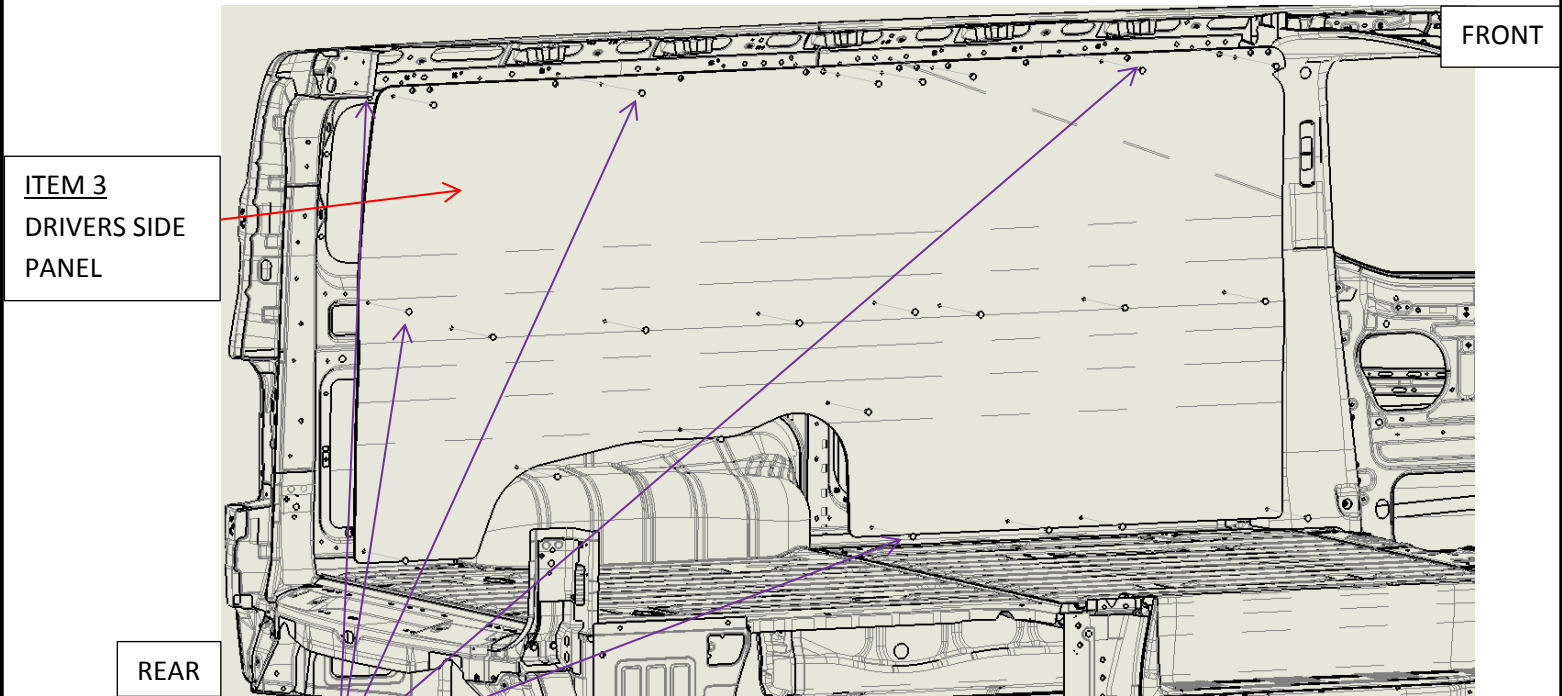

**1:** Install Item 3, Driver Side Panels.

- Align wheel well edge of the panel with the feature on the vehicle; position the contour of the panel to the vehicle wall.
- Install hardware (A) in the holes provided, on the TOP of the panel first, working your way down the panel to the BOTTOM.

**Installation completed**

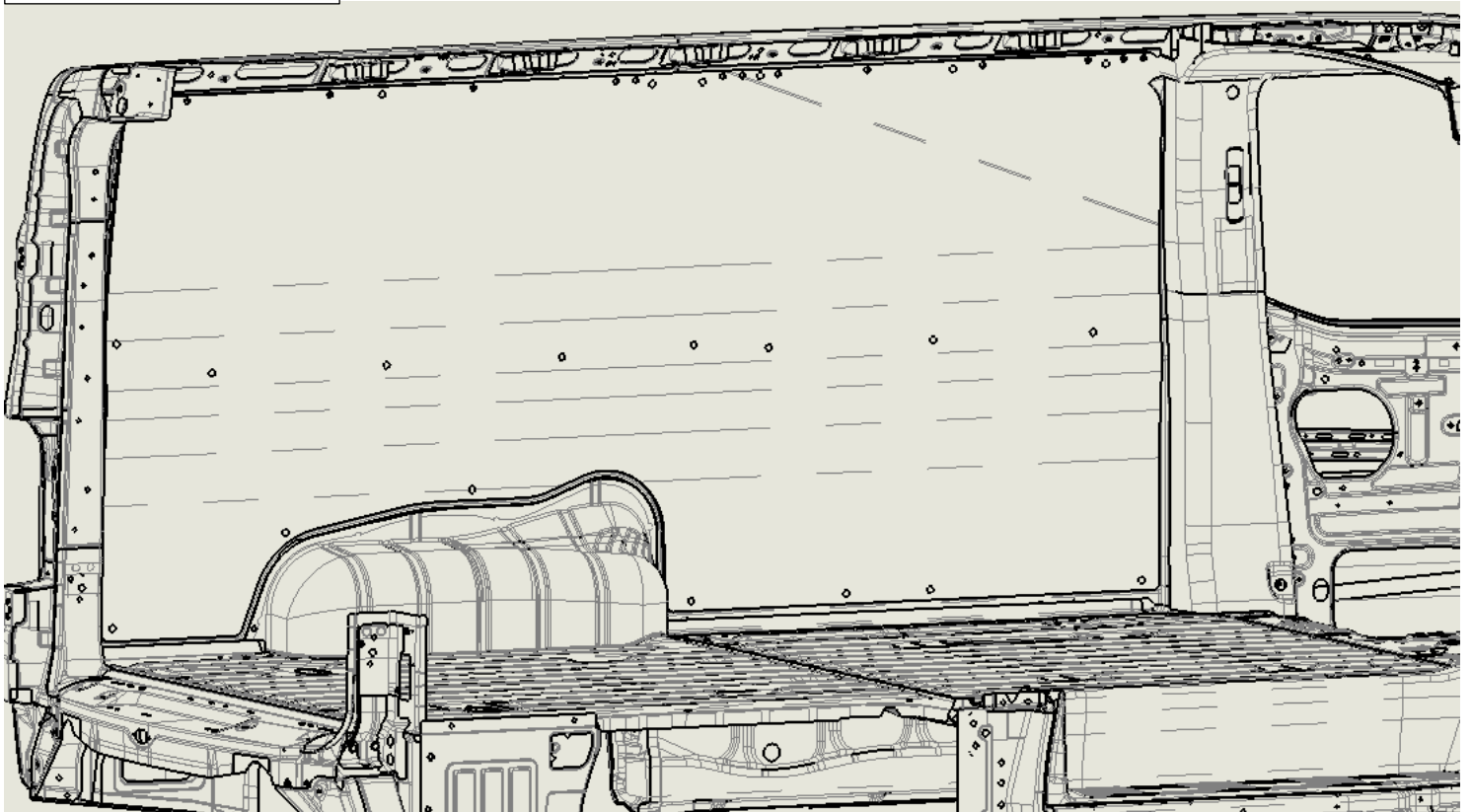

## Back Door Wall Liner Installation

ITEM 8  
REAR DOOR  
PASSENGER SIDE  
PANEL

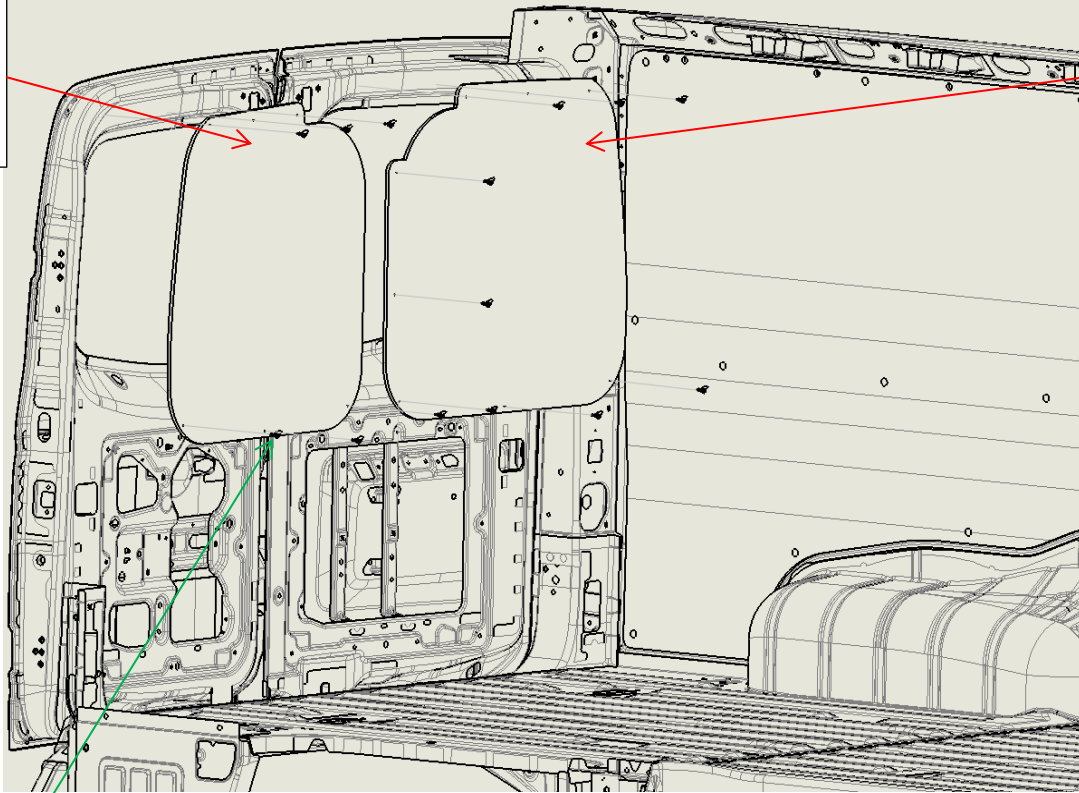

ITEM 7  
REAR DOOR  
DRIVERS SIDE  
PANEL

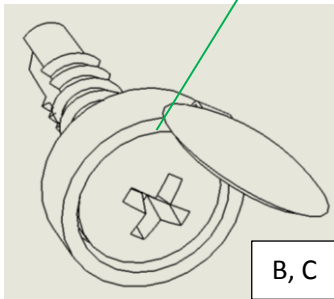

B, C

**2:** Install Item 7 and 8, Rear door panels,

**Note:** Rear doors must be closed when installing door panels.

- Align the panels with the door contour; **do not mount tight against the door seals.**
- Install hardware (B, C) on the bottom of the panel first, working your way up the panel to the top.

Installation completed

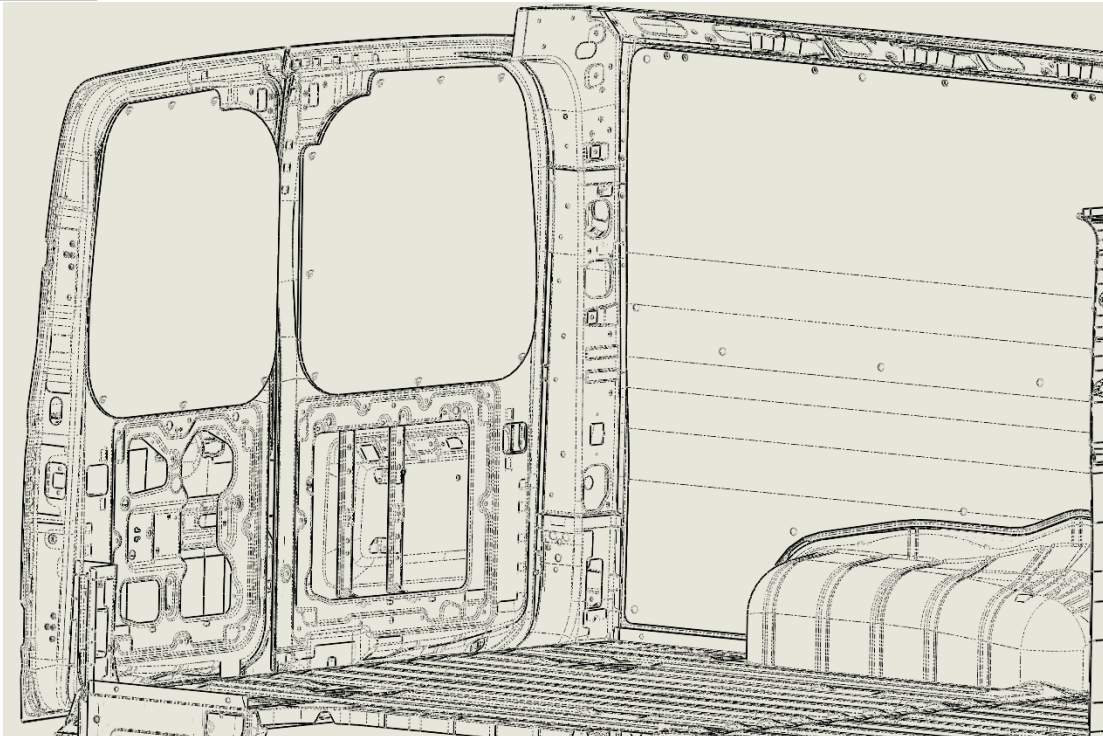



# Passenger Side Wall Liner Installation

ITEM 1  
SLIDING DOOR  
PANEL

ITEM 9 REAR PASSENGER  
SIDE PANEL

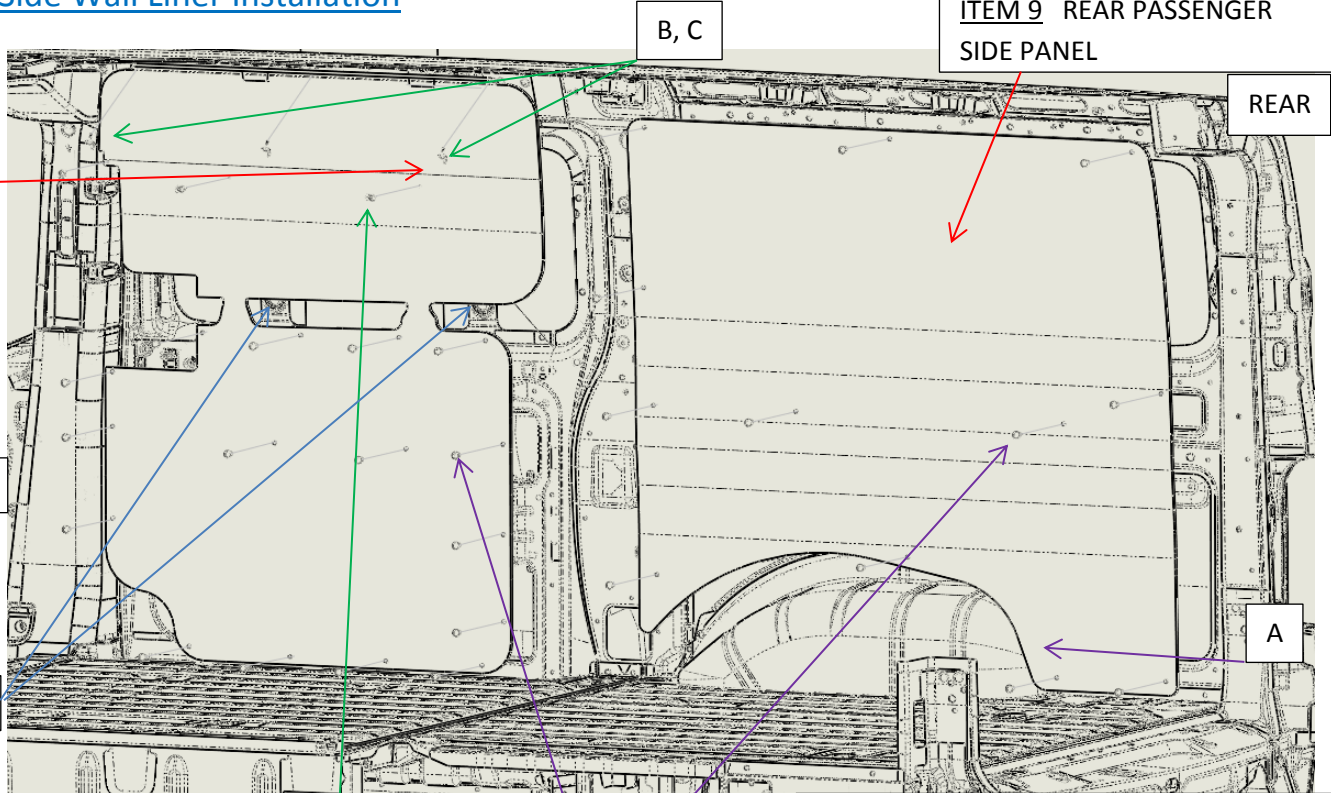

FRONT

REAR

\*DOOR RIBS

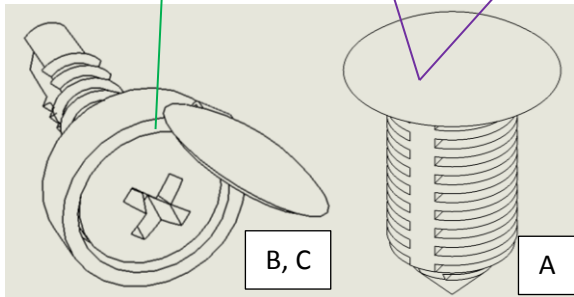

B, C

A

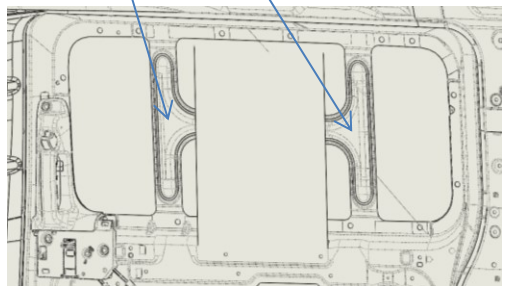

Installation completed

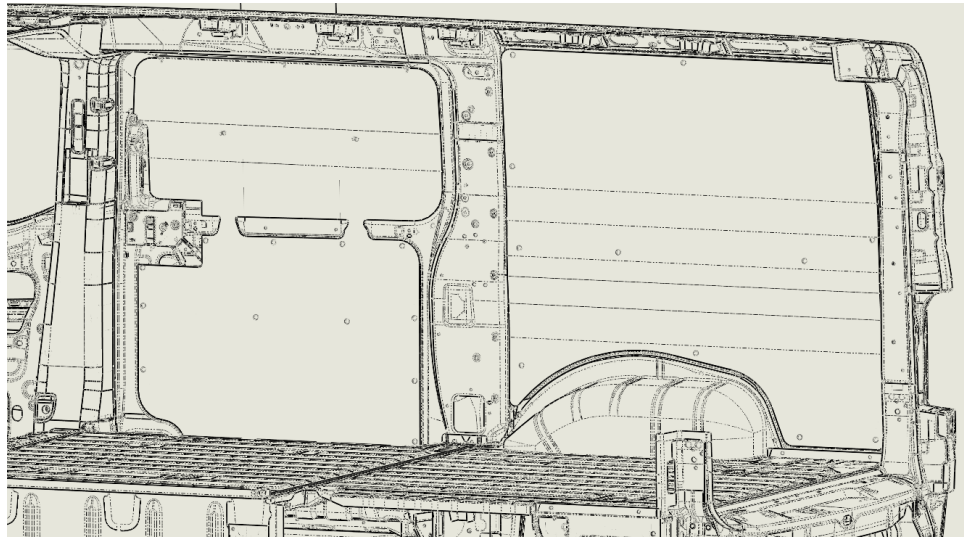

- 3:** Install Item 9, Rear Passenger Side Panel.
- Align wheel well edge of the panel with the feature on the vehicle; position the contour of the panel to the vehicle wall.
  - Install hardware (A), in the holes provided, on the bottom of the panel first, working your way up the panel to the top.
  - **4:** Install Item 1, Sliding Door Panel.  
First remove OEM bottom panel. Note: Sliding door must be closed to install panel;
  - Insert panel into the sliding door sill cavity, align holes at the bottom panel to the one on the door and insert hardware (A) in all of the holes provided.
  - Install hardware (B, C) first in the holes provided in the middle part of the upper section of the panel into the **door ribs, do not over tighten**, then install hardware at the top and by the handle; make sure the panel does not interfere with the door seal.

## Ceiling Liner Installation

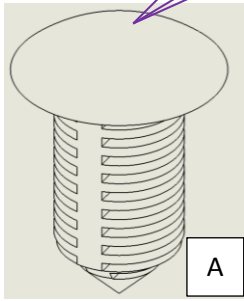
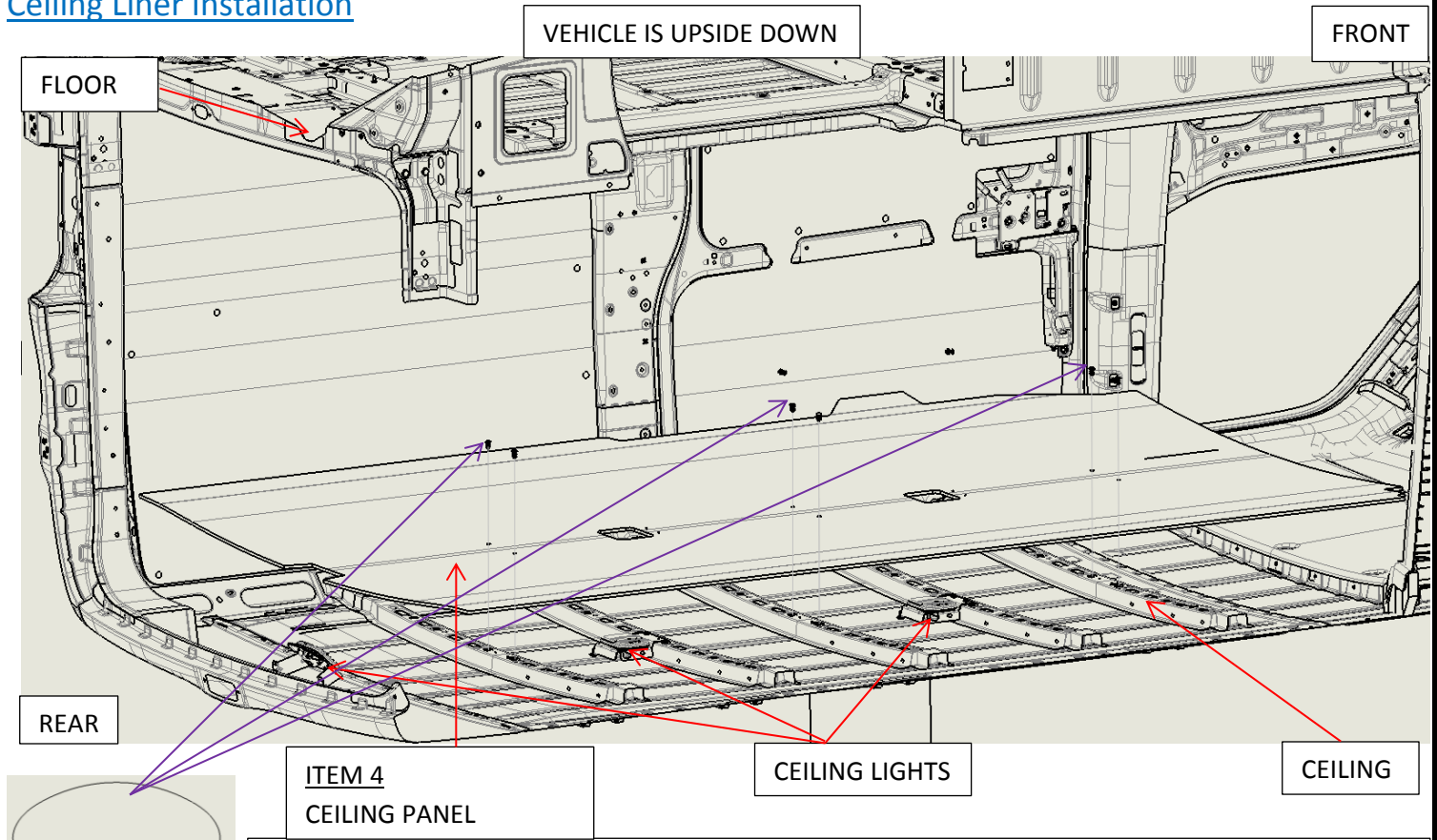

### 5: Install Item 4, Ceiling Panel.

- Align Ceiling panel with the light features on the ceiling of the vehicle, insert the front of the panel between the headliner and the roof.
- Align the holes at the center of the panel with the holes in the ceiling cross bows and install hardware (A) on each side; this will align the panel with the ceiling.
- Push the panel against the ceiling and install hardware (A), in the holes provided starting from the front working your way towards the rear.

### Installation completed

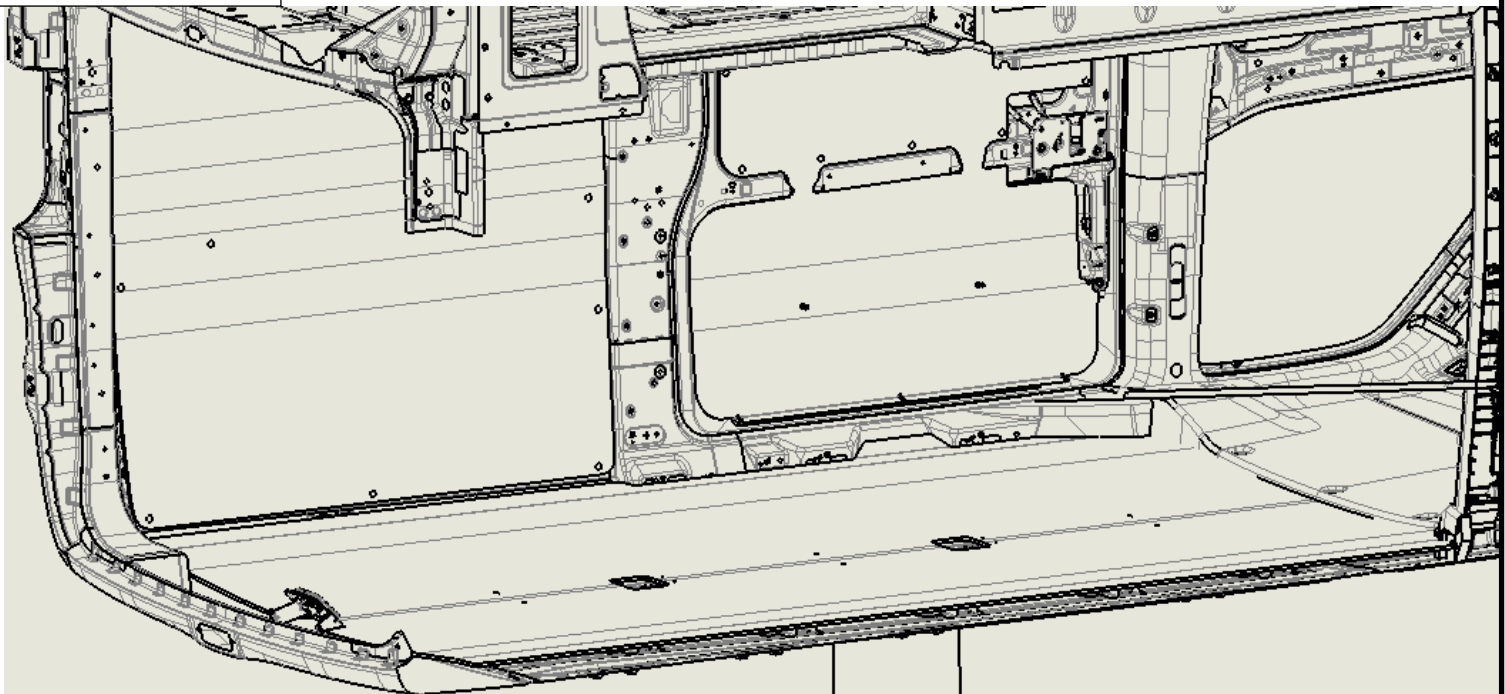

# Ceiling Sills Installation

VEHICLE IS UPSIDE DOWN

PASSENGER SIDE

FRONT

ITEM 13  
CEILING SILL B

WALL

ITEM 11  
CEILING SILL A

REAR

CEILING

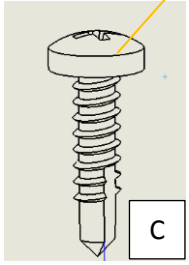
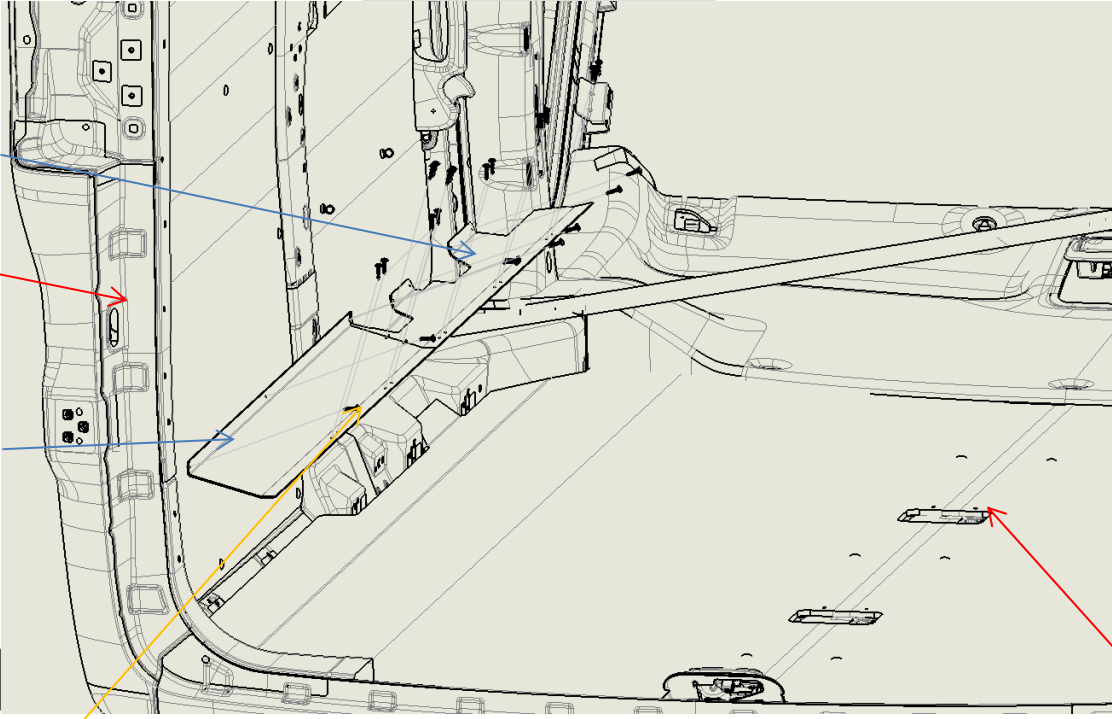

- 6:** Assemble Item 11 and 13 together with the Item 12, Sill Joining Plate (SHOWN BELOW), with hardware (C) in the holes provided.  
FOR DRIVER SIDE.
- Assemble Item 10 and 14 together with the Item 12, Sill Joining Plate (SHOWN BELOW), with hardware (C) in the holes provided.  
FOR PASSENGER SIDE
  - Install the Sill assemblies on the Driver side as well as on the Passenger side using hardware (C) in the holes provided on the Sills.

**Installation completed**

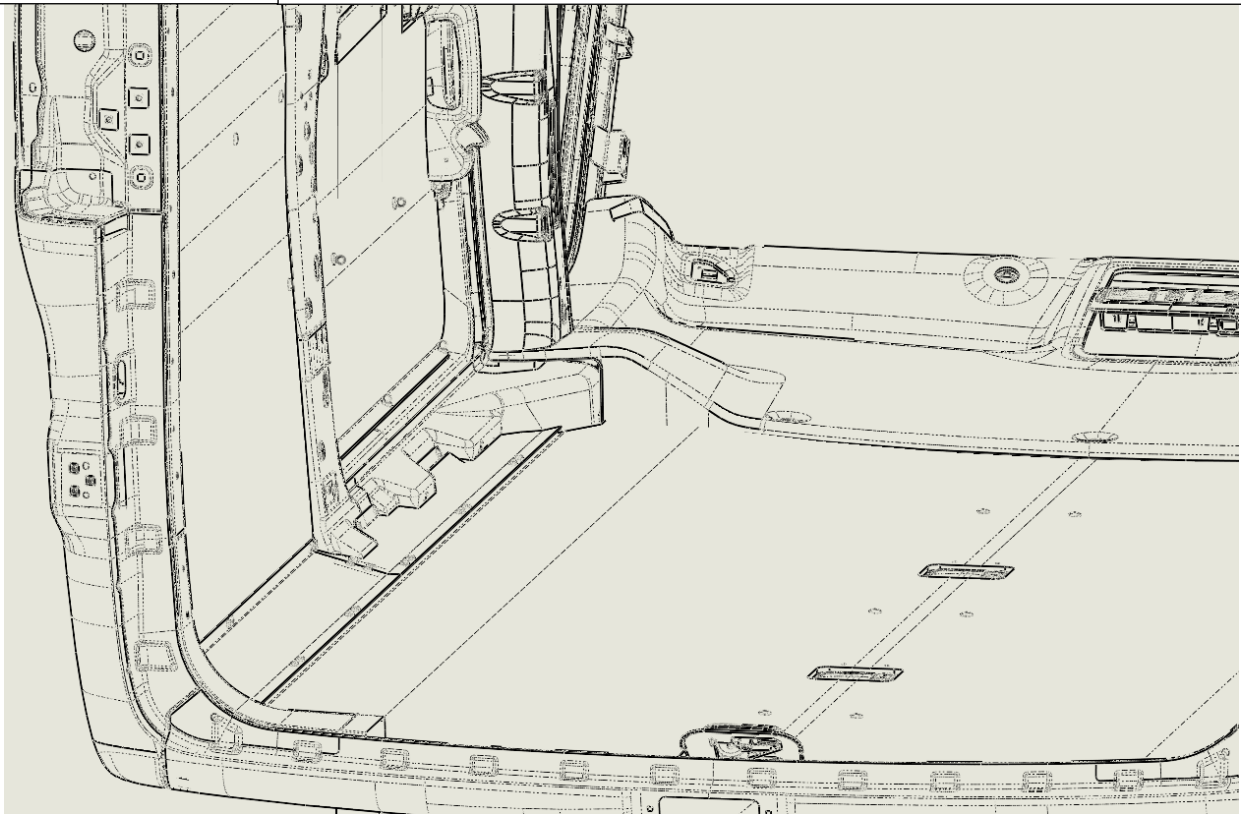

ITEM 12  
SILL  
JOINING  
PLATE

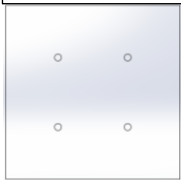



# Ceiling Sills Installation Details

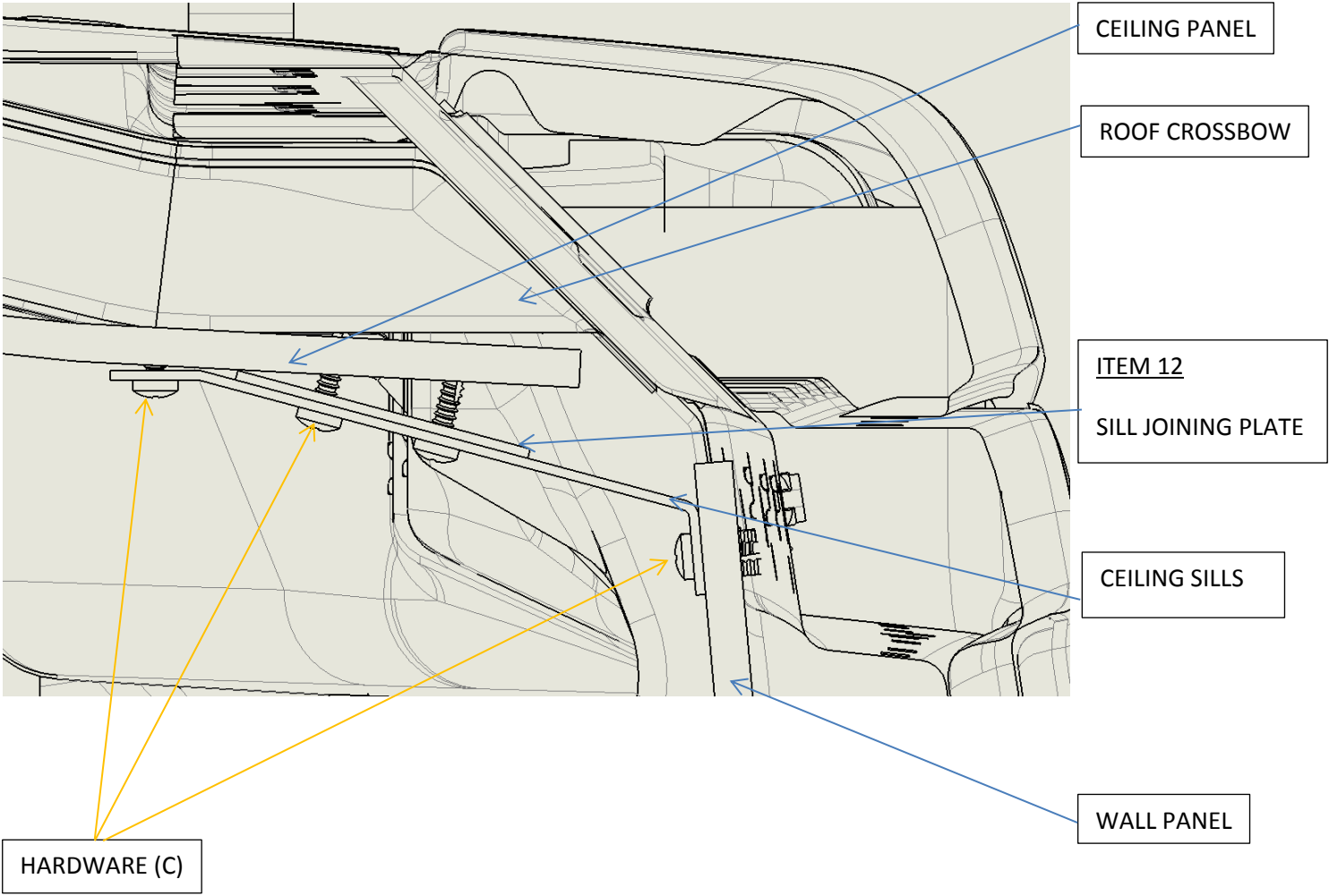



Installation completed

PASSENGER SIDE SILLS

ITEM 10

ITEM 14

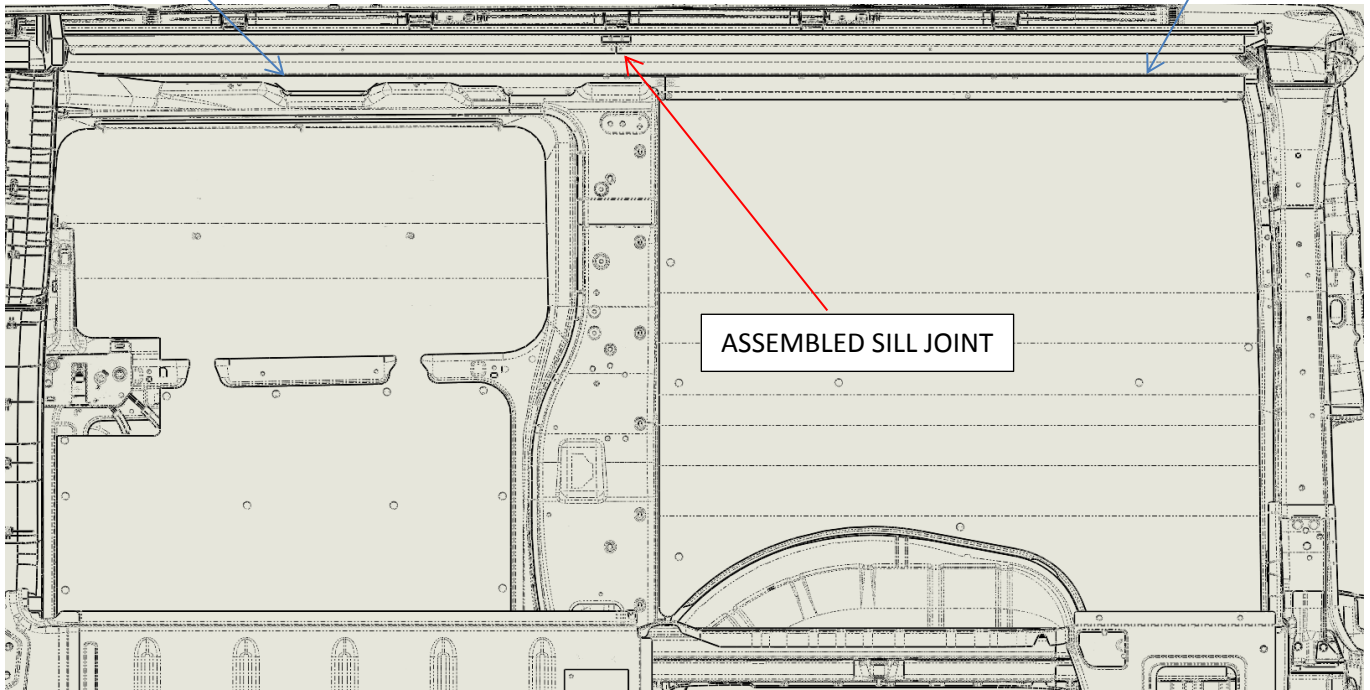

DRIVER SIDE SILLS

ITEM 11

ITEM 13

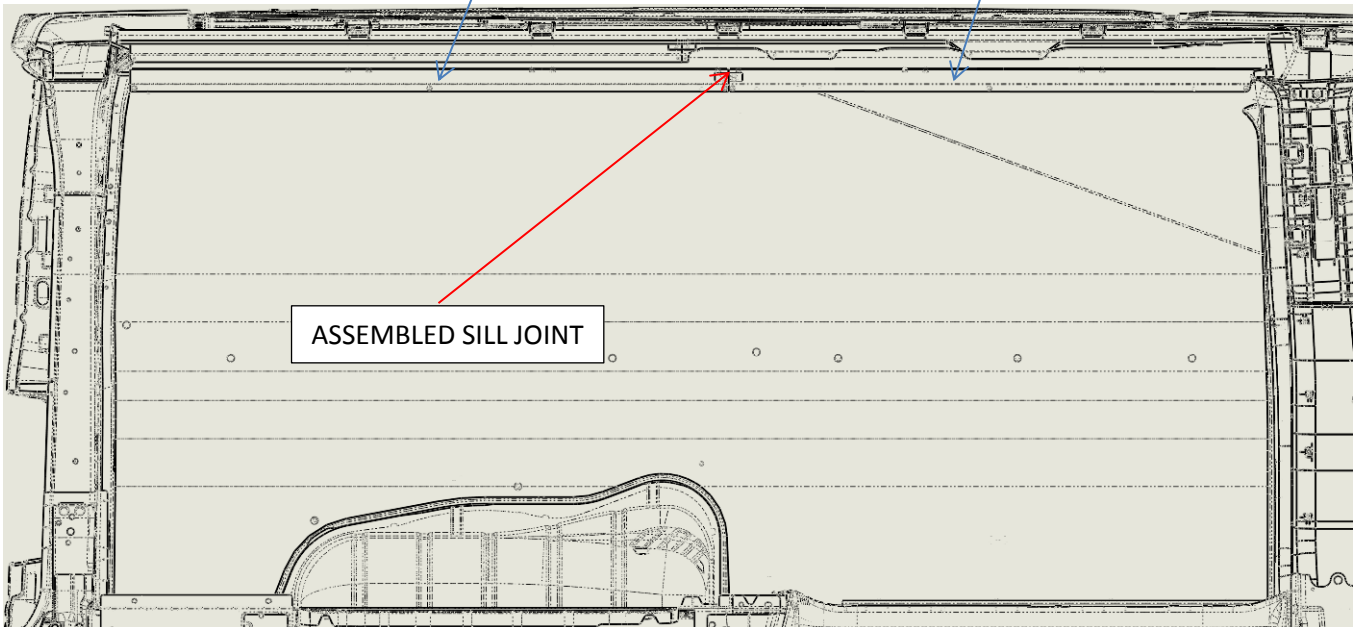

# Floor and Floor Sill Installation

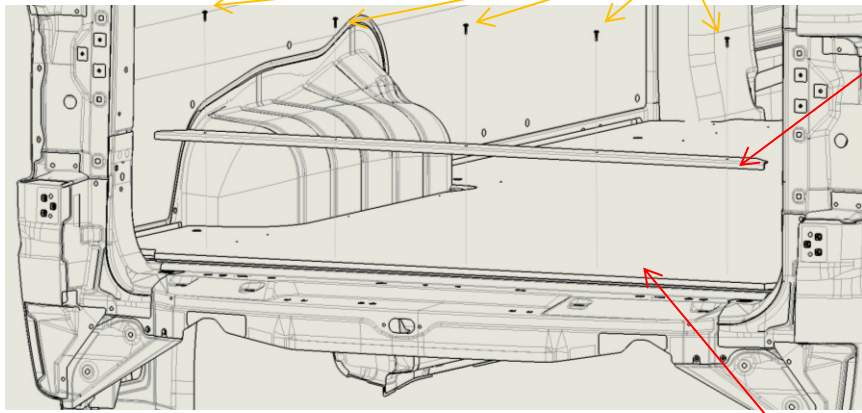

**ITEM 16**  
FLOOR SILL – REAR DOOR

**7:** Install Items 2, FLOOR and Items 16, 17 FLOOR SILLS.

- Install floor inside the vehicle.
- Align the floor sills in their proper location with the floor edges and install hardware (C).

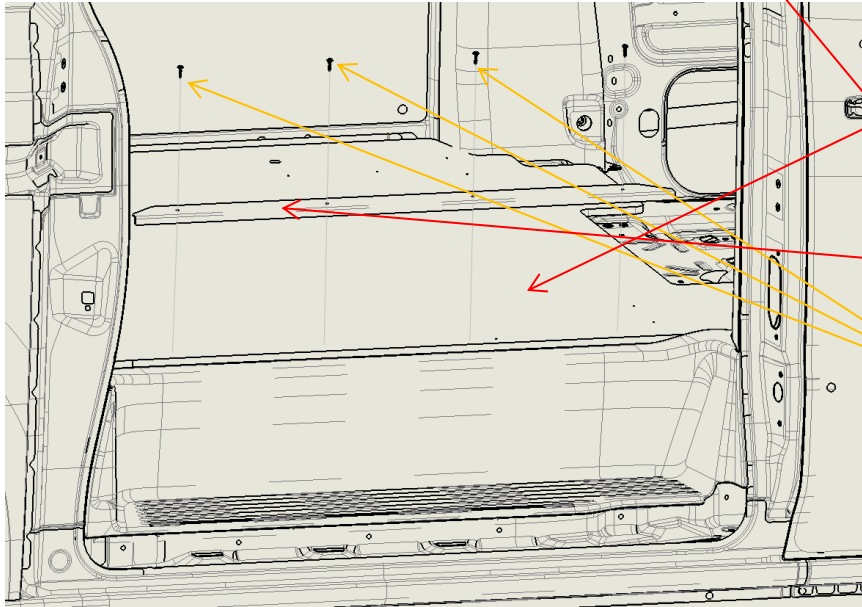

**ITEM 2**  
FLOOR

**ITEM 17**  
FLOOR SILL – SLIDING DOOR

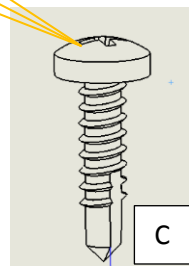

**Installation completed**

