

PROMASTER CITY WALL LINERS INSTALLATION INSTRUCTIONS



NOTES:

1. Before commencing, remove all wall liners and “D” Rings already installed in the vehicle.
2. Consult layout PDF and compare vehicle layout allocated Legend.
3. Prepare hardware shown below and have them ready for installation.
4. Wall liners will be installed in the order shown in the instructions.
5. A drill with a Phillips driver is required to install hardware (**C**) #8 Screws, shown below.
6. Reinstall all “D” Rings once the wall liner kit installation is completed.

Hardware

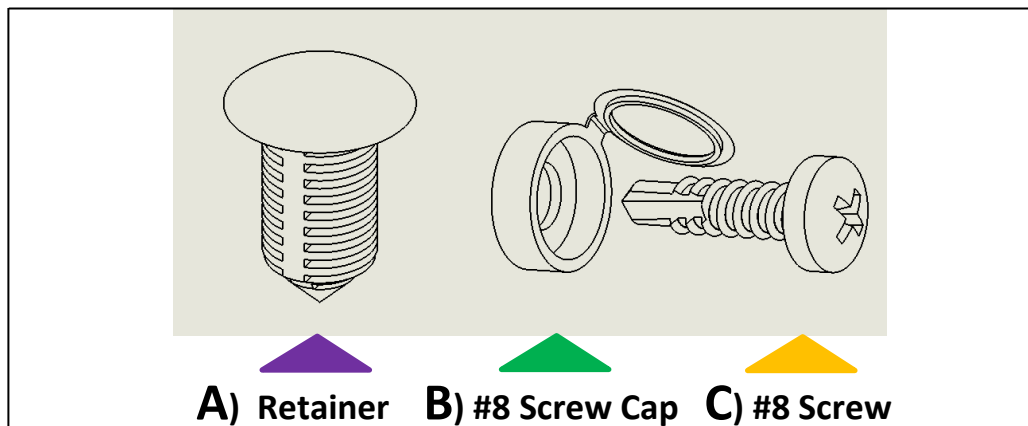

PROMASTER CITY WALL LINERS

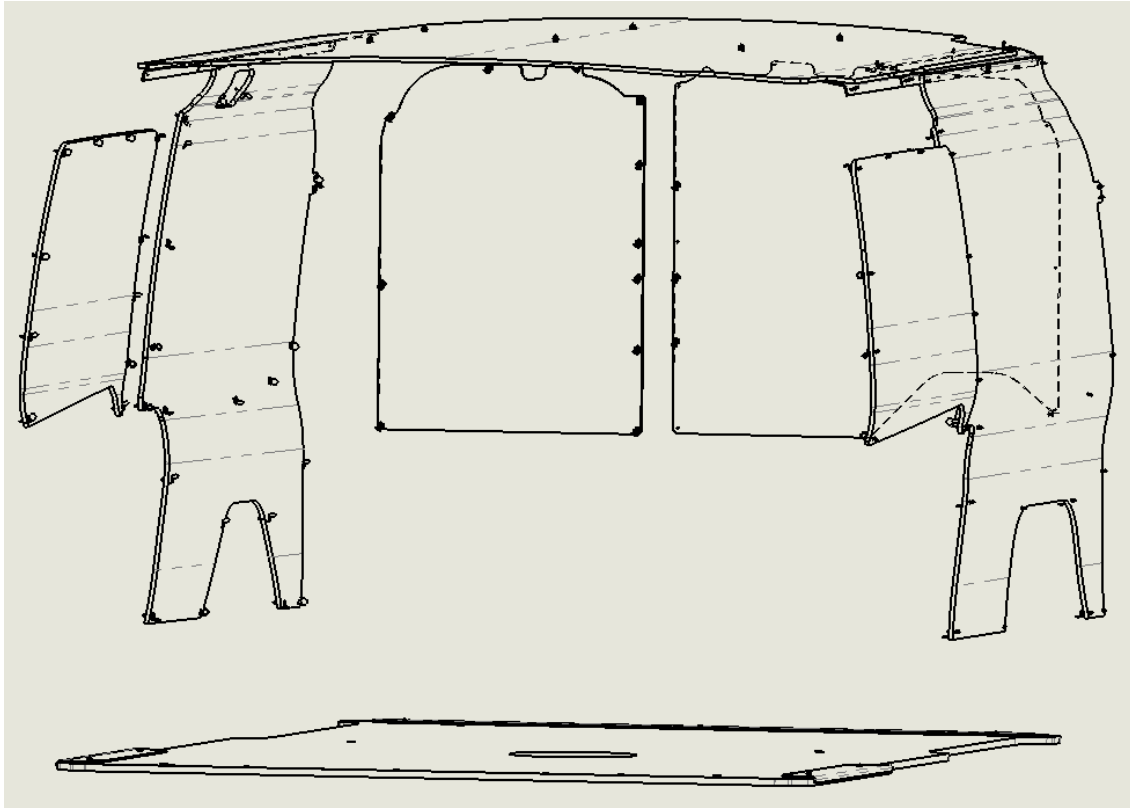

ITEM NO.	PART NUMBER	DESCRIPTION	QTY.
1	672-xxx-6541	FLOOR - PROMASTER CITY	1
2	673-114-2613	GREY SLIDING DOOR PANEL DRIVER SIDE PROMASTER CITY	1
3	673-114-2613	GREY SLIDING DOOR PANEL PASSENGER SIDE PROMASTER CITY	1
4	SCREW CAP	SCREW CAP	84
5	SCREW	SCREW - PHIL. PAN HD #8X.75 SELF DRILLING	123
6	674-114-2613	GREY REAR PANEL DRIVER SIDE PROMASTER CITY	1
7	675-114-2613 CND OEM	CEILING PANEL CDN OEM PARTITION PROMASTER CITY	1
8	673-114-2613	GREY DOOR PANEL DRIVER SIDE PROMASTER CITY	1
9	673-114-2613	GREY DOOR PANEL PASSENGER SIDE PROMASTER CITY	1
10	678-151-1010	SILL- FLOOR- REAR DOOR PROMASTER CITY	1
11	676-151-1010	SILL- FLOOR- SIDE DOOR PROMASTER CITY	2
12	674-114-2613	GREY REAR PANEL PASSENGER SIDE PROMASTER CITY	1
13	677-151-1010	CEILING SILL "B" REAR DRIVER SIDE PROMASTER CITY	1
14	677-151-1010	CEILING SILL "A" REAR PASSENGER SIDE PROMASTER CITY	1
15	677-151-1010	JOINER PLATE- CEILING SILL	2
16	677-151-1010	CEILING SILL "A-1" FRONT PASSENGER SIDE PROMASTER CITY	1
17	677-151-1010	CEILING SILL "B-1" FRONT DRIVER SIDE PROMASTER CITY	1
18	RETAINER	RETAINER- BLACK NYLON	6

Note:

Model may differ depending if the vehicle purchased came with an OEM partition or not and if it is a US or Canadian model.

Driver Side Wall Liner Installation

ITEM 6
REAR DRIVERS SIDE PANEL

ITEM 2
SLIDING DOOR
PANEL
DRIVERS SIDE

TAB*

REAR

FRONT

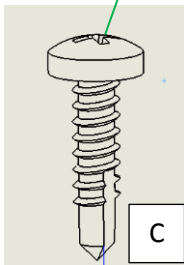

C

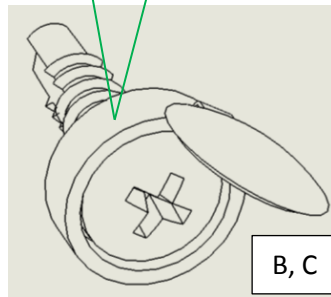

B, C

Installation completed

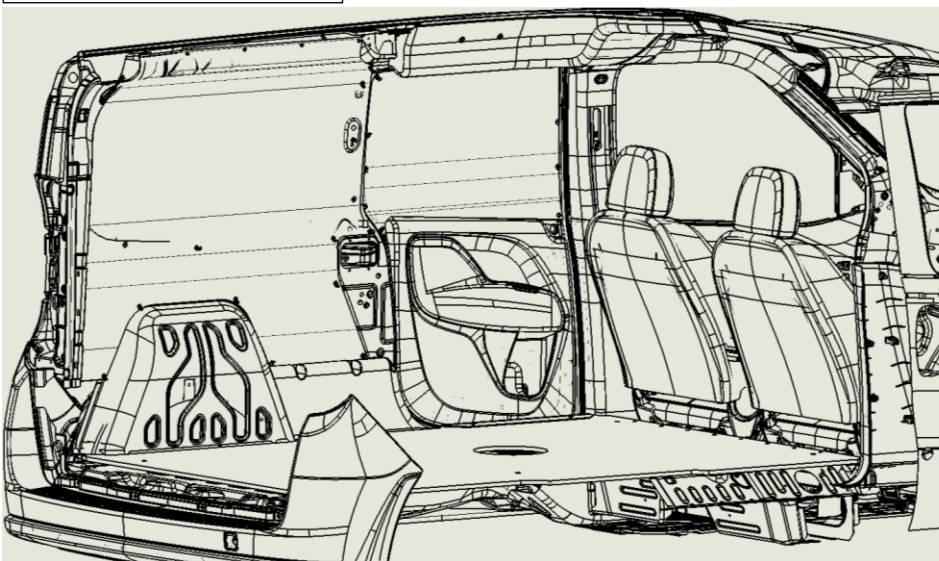

1: Install Item 2, Sliding door Driver Side Panel.

- Align notch and edge of panel with the feature on the vehicle driver side sliding door then align opposite side of panel edge with the contour features.
- Install hardware (B,C), in the holes provided, on the bottom of the panel first, working your way up the panel to the top.

2: Install Item 6, Rear Driver Side Panels.

- Align wheel well edge of the panel with the feature on the vehicle; position the contour of the panel to the vehicle wall.
- Install hardware (C), in the holes provided at the top of the panel only then Install hardware (B,C), on the bottom of the panel, working your way up the panel up each side.
- * Push the rear middle section of the panel into the wall cavity the Install hardware (B,C) into the tab holes provided, identified on the top picture left side.

Back Door Wall Liner Installation

ITEM 9
REAR DOOR
PASSENGER SIDE
PANEL

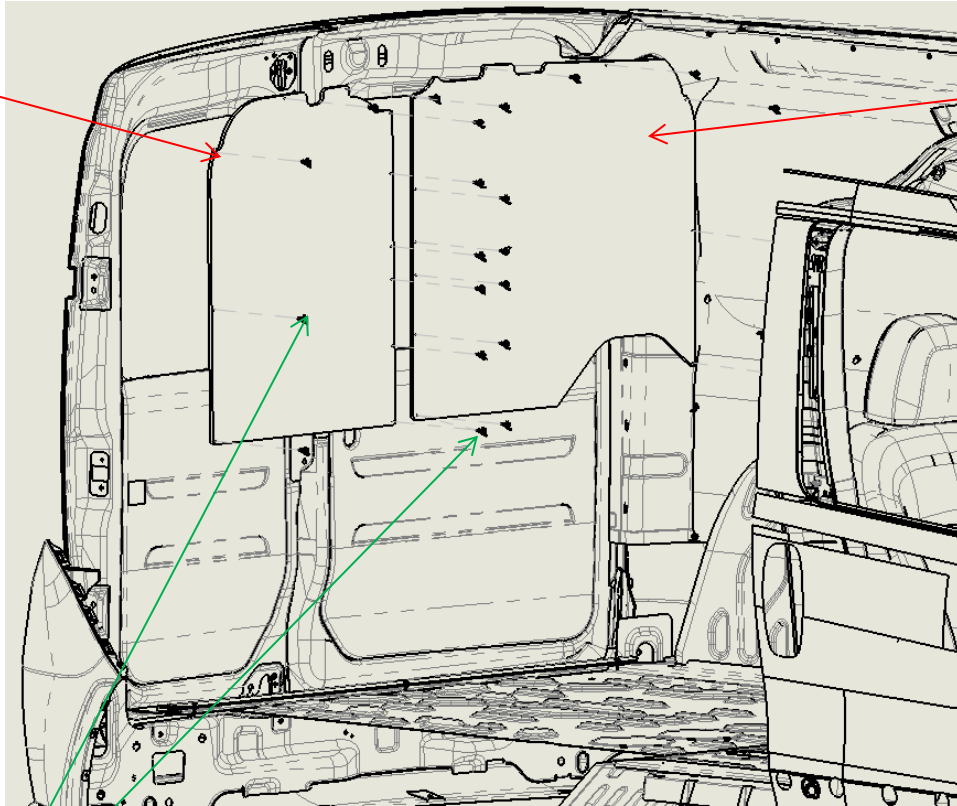

ITEM 8
REAR DOOR
DRIVERS SIDE
PANEL

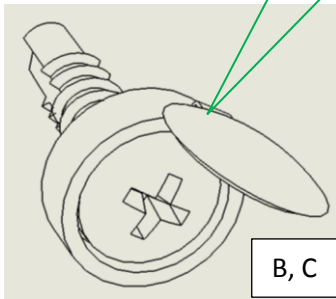

3: Install Item 8 and 9, Rear door panels,

Note: Rear doors must be closed when installing door panels.

- Align the panels with the upper door contours, do not mount tight against the door seals.
- Install hardware (B, C) on the top of the panel first, working your way down the panel to the bottom.

Installation completed

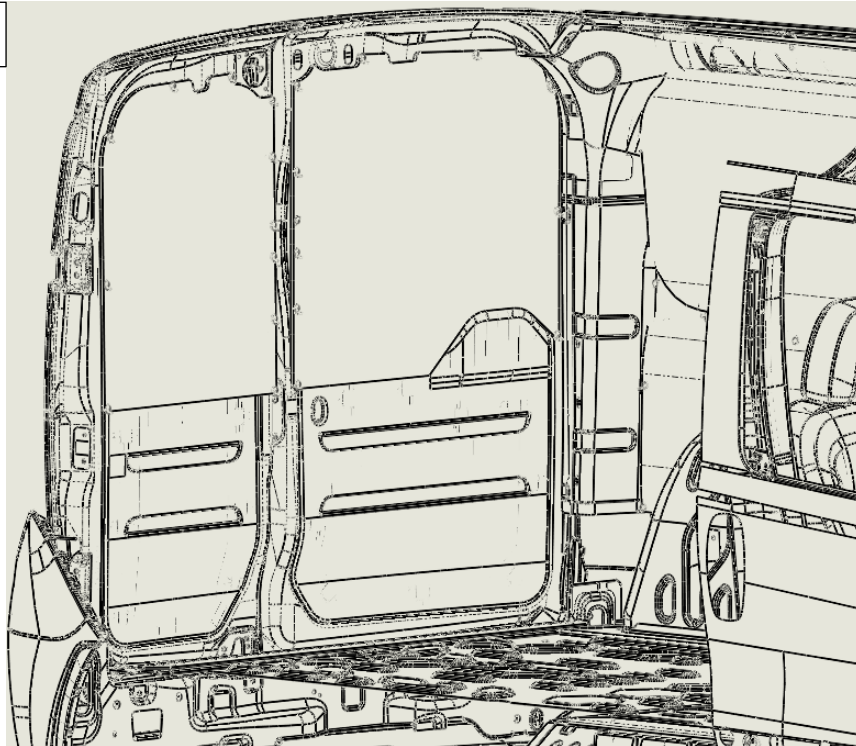

Passenger Side Wall Liner Installation

ITEM 3
SLIDING DOOR
PANEL

B, C

C

ITEM 12
REAR PASSENGER
SIDE PANEL

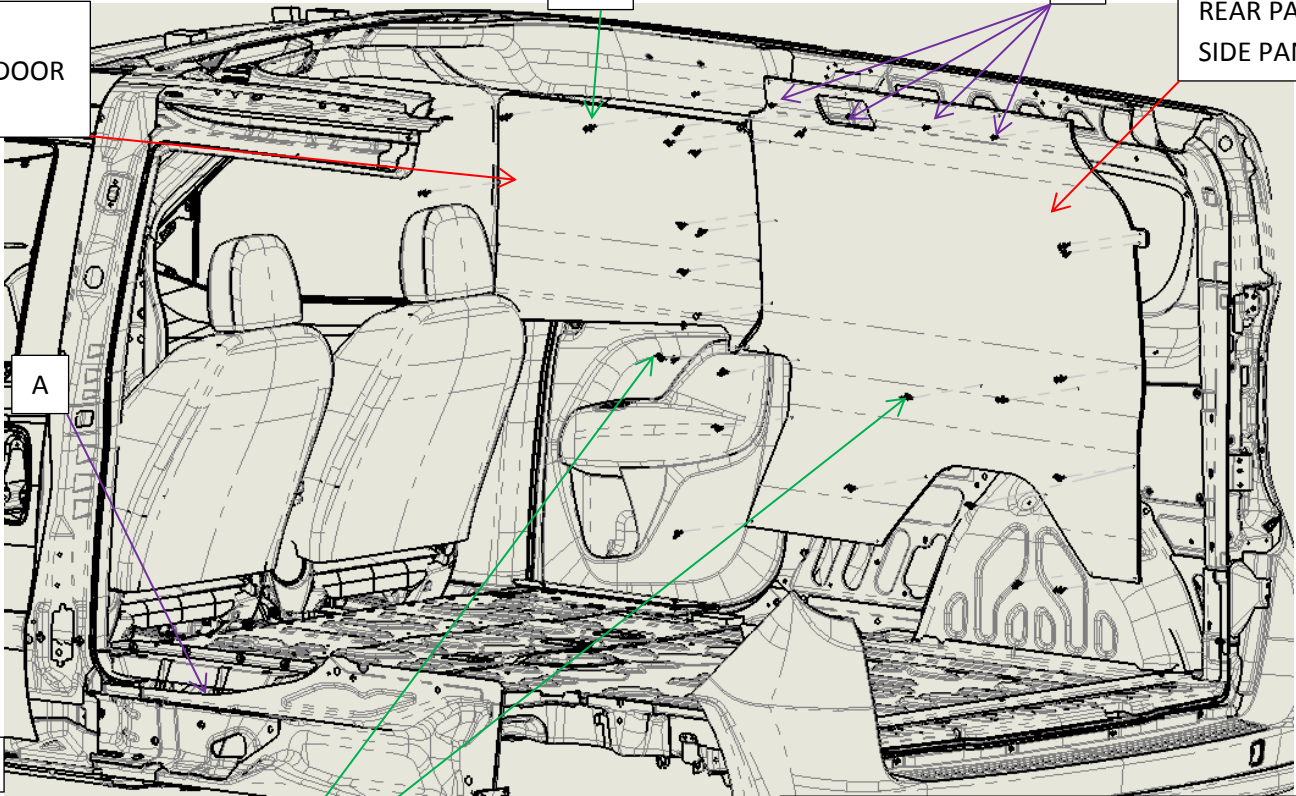

FRONT

REAR

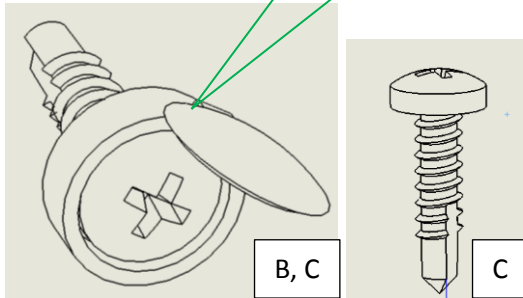

B, C

C

4: Install Item 12, Rear Passenger Side Panel.

- Align wheel well edge of the panel with the feature on the vehicle as well as the light opening; position the contour of the panel to the vehicle wall.
- Install hardware (C), in the holes provided at the top of the panel only then Install hardware (B,C), on the bottom of the panel, working your way up the panel up each side.
- * Push the rear middle section of the panel into the wall cavity the Install hardware (B,C) into the tab holes provided, identified on the top picture left side.

Installation completed

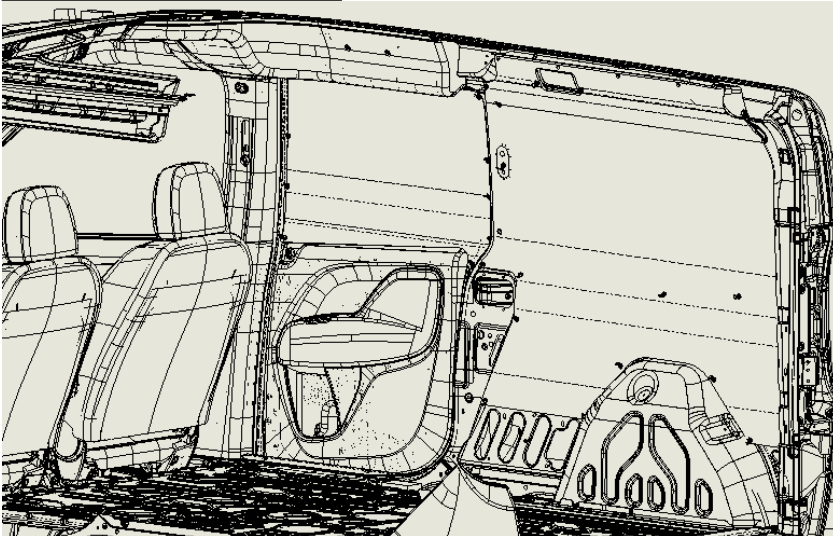

5: Install Item 3, Sliding Door Panel.

First remove OEM bottom panel.

Note: Sliding door must be closed to install panel;

- Align notch and edge of panel with the feature on the vehicle driver side sliding door then align opposite side of panel edge with the contour features.
- Install hardware (B,C), in the holes provided, on the bottom of the panel first, working your way up the panel to the top.

Ceiling Liner Installation

VEHICLE IS UPSIDE DOWN

FRONT

FLOOR

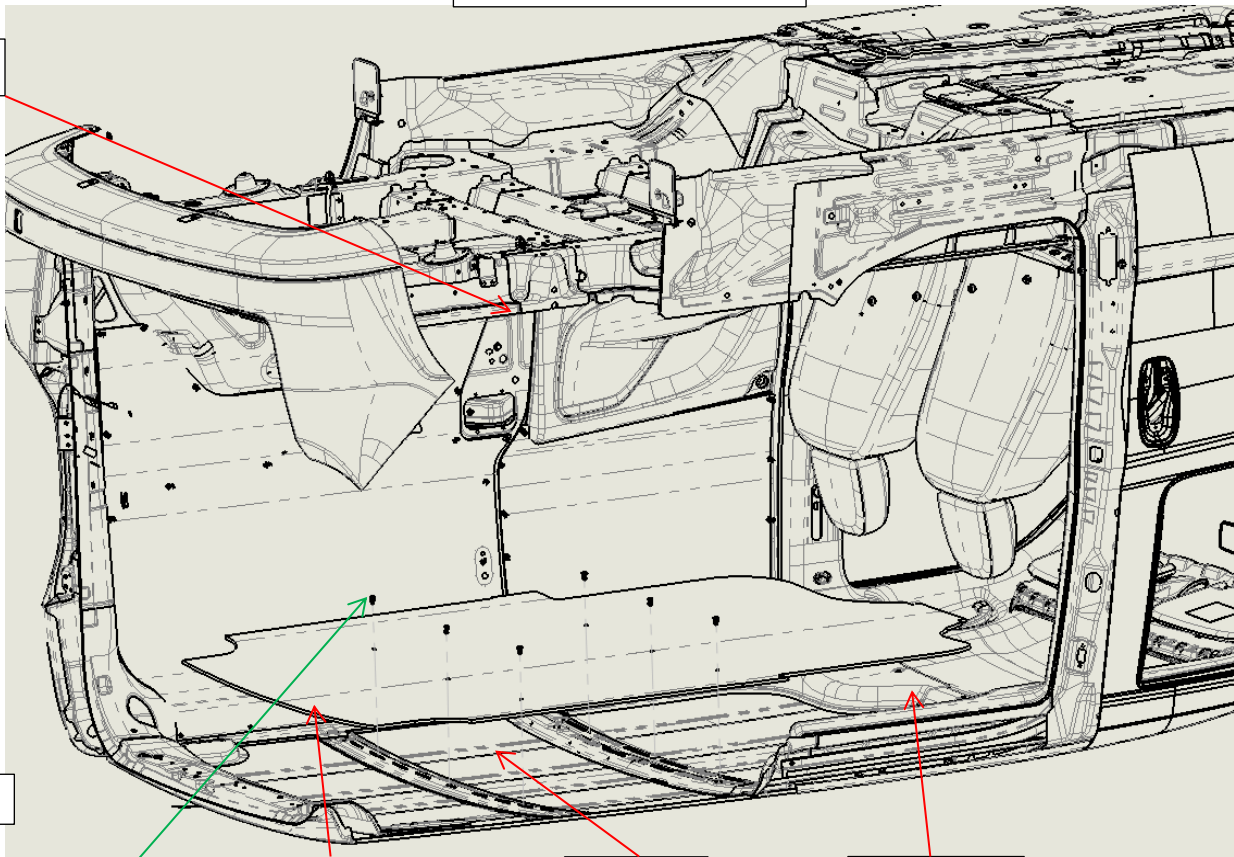

REAR

ITEM 7
CEILING PANEL

CEILING

HEADLINER

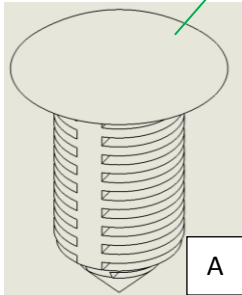

A

6: Install Item 7, Ceiling Panels.

- Align Ceiling panel with the feature on the vehicle in the front, insert the front of the panel between the headliner and the roof.
- Align the outside holes at the center of the panel with the holes in the ceiling cross bows and install hardware (A) on each side; this will align the panel with the ceiling.
- Push the panel against the ceiling and install hardware (A), in the holes provided starting from the front working your way towards the rear.

Installation completed

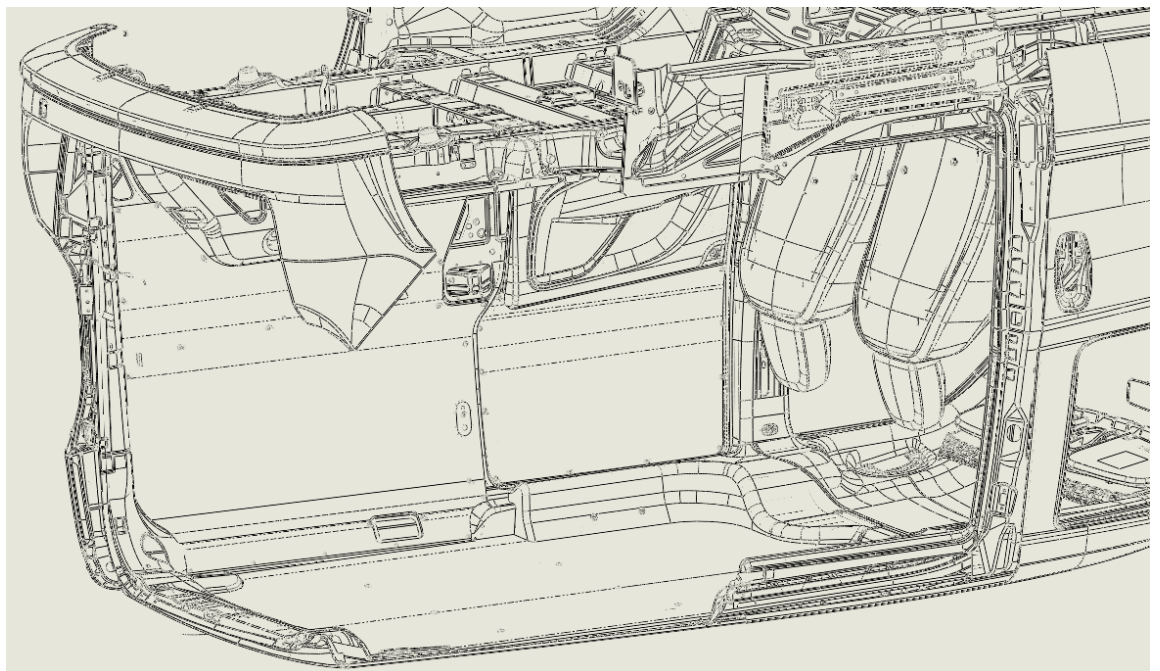

Ceiling Sills Installation

VEHICLE IS UPSIDE DOWN

PASSENGER SIDE

FRONT

ITEM 14
CEILING SILL A

WALL

REAR

CEILING

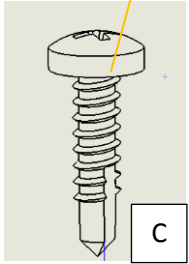
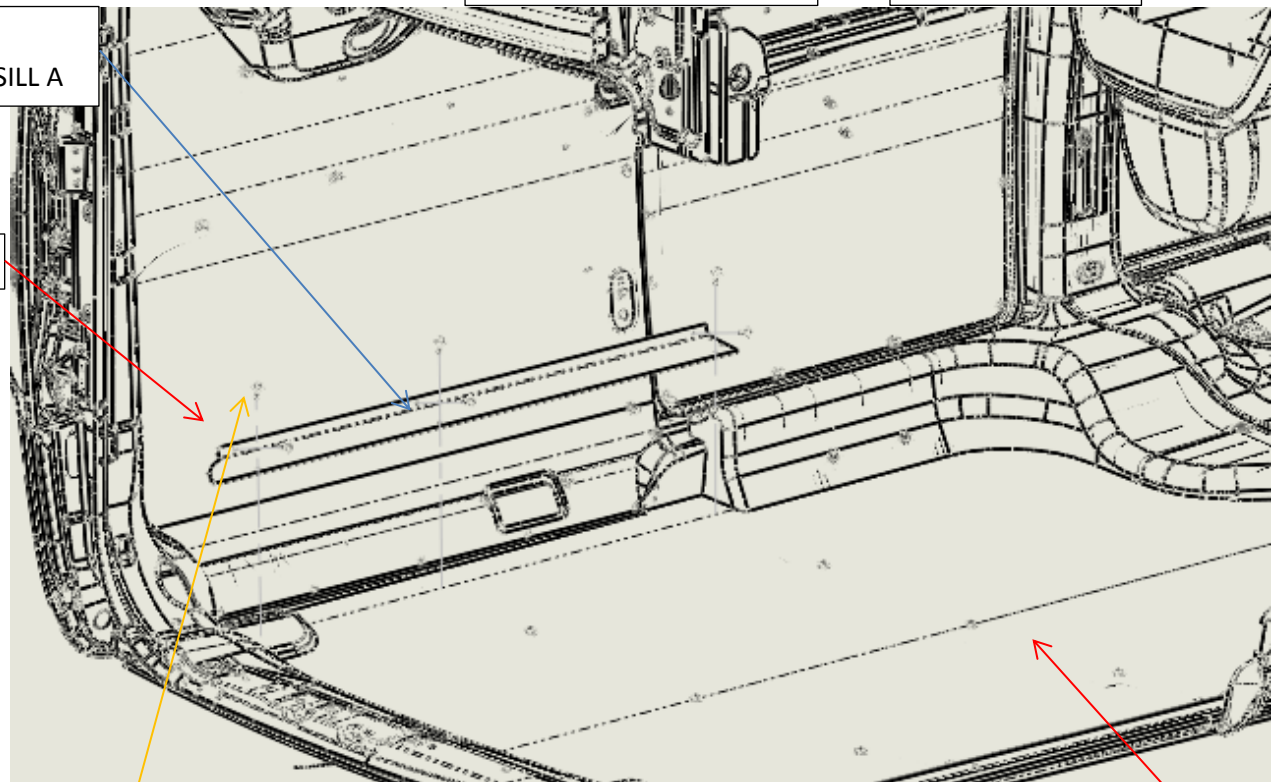

C

- 7** Install Item 14 on Passenger side with hardware (C) in the holes provided for US model.
- Install Item 14 and item 16 together with the Item 15, Sill Joining Plate (SHOWN BELOW), with hardware (C) in the holes provided for CANADIAN model.
- FOR PASSENGER SIDE**
- Install Item 13 on Driver side with hardware (C) in the holes provided for US model.
 - Install Item 13 and item 17 together with the Item 15, Sill Joining Plate (SHOWN BELOW), with hardware (C) in the holes provided for CANADIAN model.
- FOR DRIVER SIDE**

Installation completed

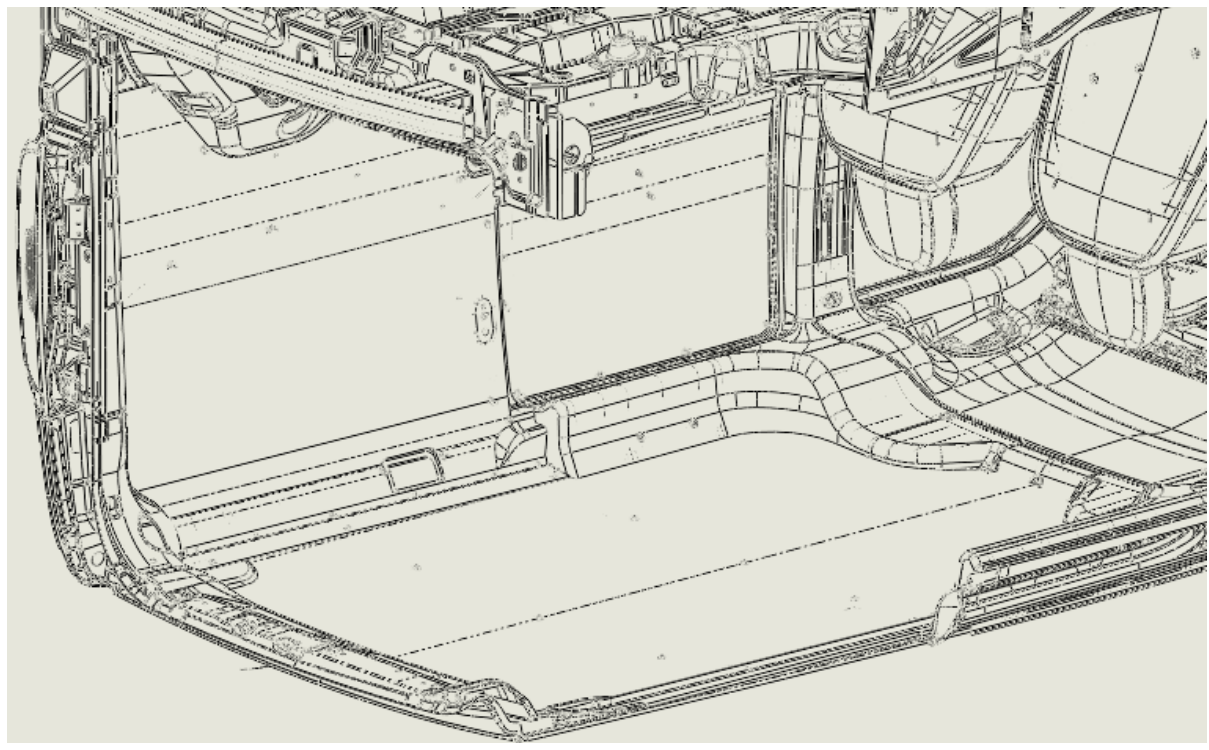

ITEM 15
SILL JOINING PLATE
(for CANADIAN models only)

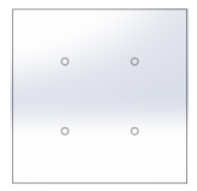

Ceiling Sills Installation Details

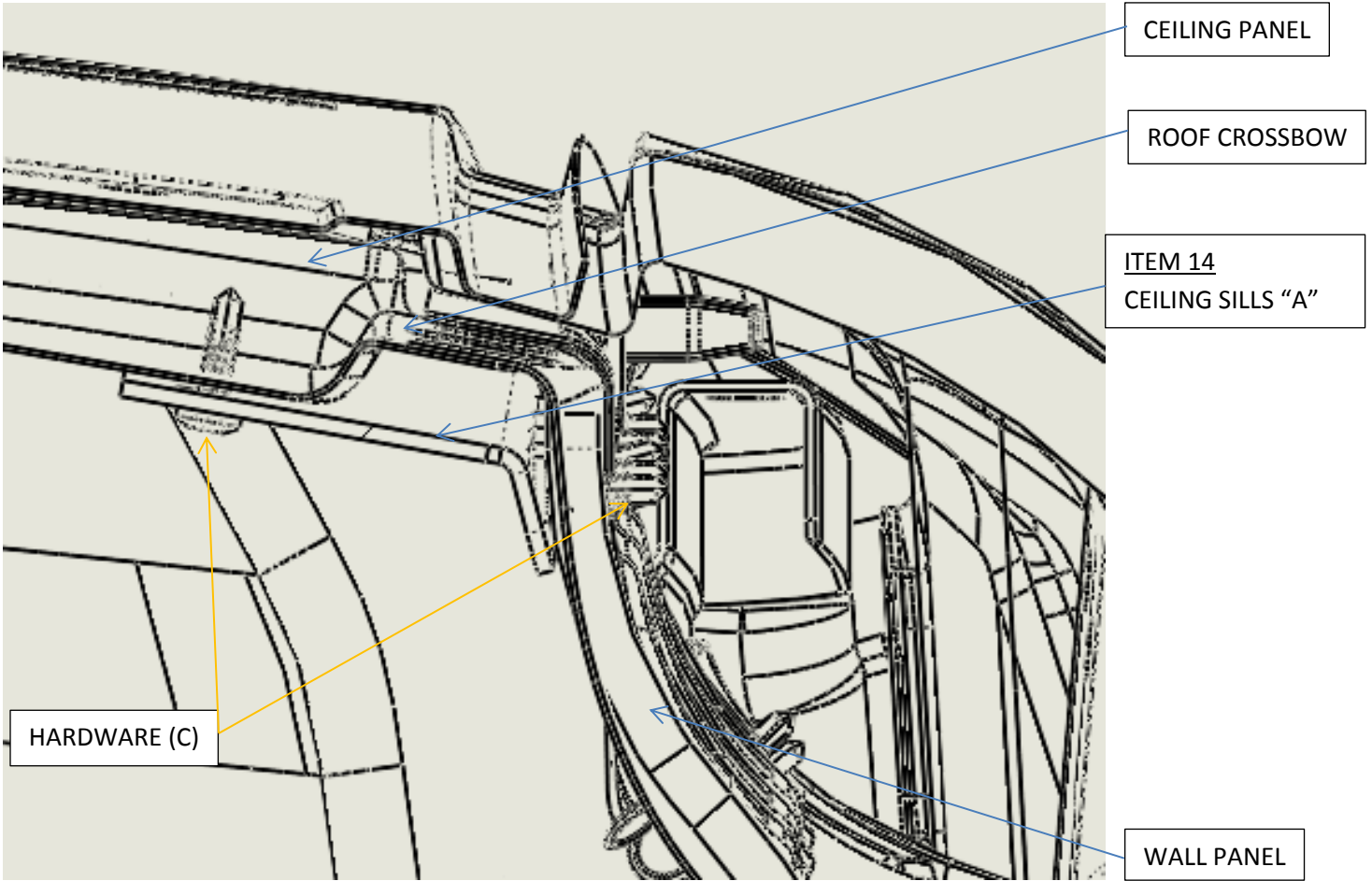

IMPORTANT NOTE :

ITEM 7 CEILING PANEL PROFILES

- The Ceiling panel is delivered with the OEM Partition profile for both the Canadian and US models.
- If the vehicle you have ordered does not have the OEM Partition you will need to cut the panel to the profile for that model.
- Use an Exacto knife to cut the excess material off by following the scored lines provided for you on the panel.

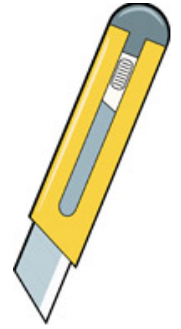

US CEILING PANEL

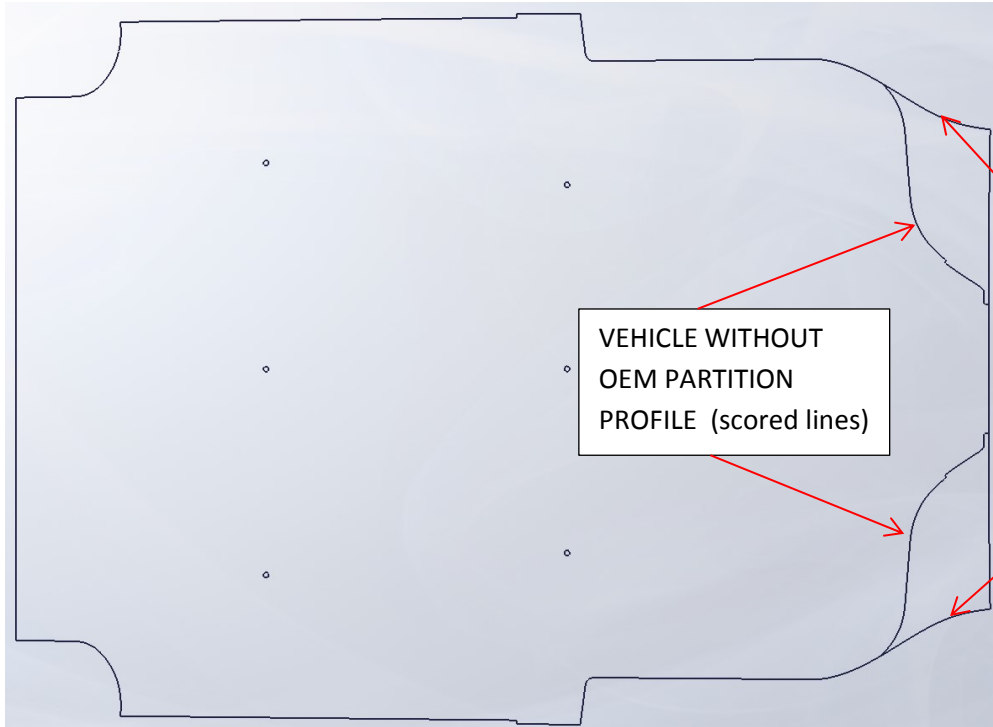

CANADIAN CEILING PANEL

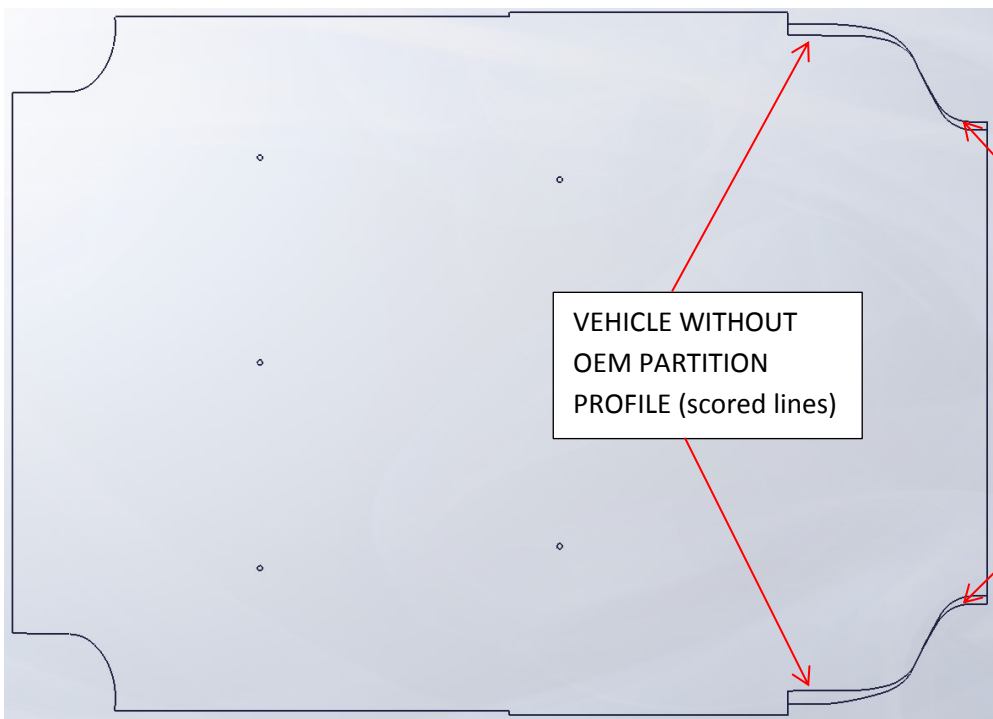

Floor and Floor Sill Installation

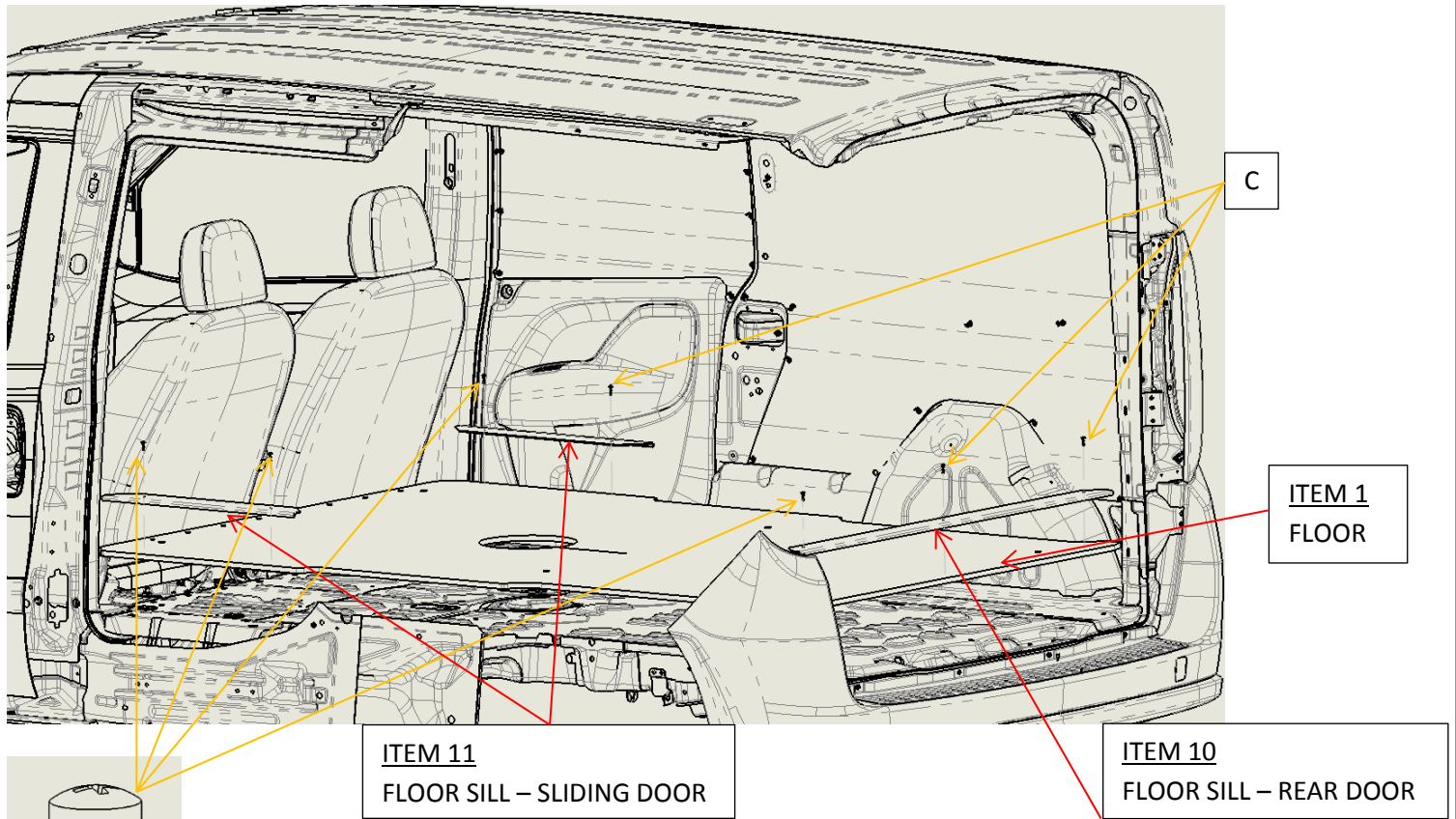

8: Install Items 1, FLOOR and Items 10, 11 FLOOR SILLS.

- Install floor inside the vehicle.
- Align the floor sills in their proper location with the floor edges and install hardware (C).

Installation completed

