

TEMPSHIELD ASSEMBLY INSTRUCTIONS

RAM PROMASTER 159" CARGO- HIGH ROOF

This document presents the detailed procedures for assembling Legend Fleet components and accessories.

Customers can make use these step-by-step procedures and easily assemble without major difficulty.



519 688 1043
customercare@legendfleet.com

56957 HWY 3 WEST,
TILLSONBURG,
ON N4G 4G8.

READ BEFORE INSTALLING YOUR TEMPShield KIT!

1. Ensure interior surfaces in van are clean, degreased and dry.
2. Install the Kit one sheet at a time by following instructions. This will reduce mess, keep things organized, and save you a lot of headache (seriously).
3. Always install Legend Insulated DuraTherm Wall Liners after TempShield. TempShield should never be installed and left bare.
4. Tip: Tape Printed Instructions to your Van Partition to easily refer to it.
5. Full instructions can be found here:
<https://www.legendsoftheroad.com/resources>



DISCLAIMER/DESCARGO DE RESPONSABILIDAD/CLAUSE DE NON-RESPONSABILITÉ



DISCLAIMER

Legend Fleet Solutions will not accept responsibility for damages resulting from improper installation. Please follow these instructions carefully. If you have any questions please contact Legend Fleet Solutions using the details below. By proceeding with the installation, you acknowledge and accept this disclaimer.



DESCARGO DE RESPONSABILIDAD

Legend Fleet Solutions no aceptará responsabilidad por los daños resultantes de una instalación incorrecta. Por favor, siga estas instrucciones cuidadosamente. Si tiene alguna pregunta, comuníquese con Legend Fleet Solutions utilizando los detalles a continuación.

Al continuar con la instalación, usted reconoce y acepta este descargo de responsabilidad.



CLAUSE DE NON-RESPONSABILITÉ

Legend Fleet Solutions n'acceptera aucune responsabilité pour les dommages résultant d'une mauvaise installation. Veuillez suivre attentivement ces instructions. Si vous avez des questions, veuillez contacter Legend Fleet Solutions en utilisant les détails ci-dessous.

En procédant à l'installation, vous reconnaissez et acceptez cette clause de non-responsabilité.

Legend Fleet Solutions

Email: customer care@legendfleet.com

Phone: 1-519-688-1043

WARNING/ADVERTENCIA/AVERTISSEMENT



- Edges of vehicle may be sharp. Wear gloves.
- Some materials may contain fiberglass. Wear appropriate PPE while handling.
- Take care when using power tools.



- Los bordes del vehículo pueden estar afilados. Usar guantes.
- Algunos materiales pueden contener fibra de vidrio. Utilice EPP adecuado durante la manipulación.
- Tenga cuidado al utilizar herramientas eléctricas.



- Les bords du véhicule peuvent être coupants. Porter des gants.
- Certains matériaux peuvent contenir de la fibre de verre. Portez un EPI approprié lors de la manipulation.
- Soyez prudent lorsque vous utilisez des outils électriques.



Table of Contents

Sheet Layouts 1-3	5
Sheet Layouts 4-6	6
Sheet Layouts 7	7
Assembly Instructions	8
Tips and Notes	8
Sheet 1	9
Sheet 2	10
Sheet 3	11
Sheet 4	12
Sheet 5	13
Sheet 6	14
Sheet 7	15
Installation Complete!	16
TempShield Kit Overview	17

Sheet Layouts 1-3

FULL SHEET

SECTIONS REQUIRED

SECTIONS NOT REQUIRED

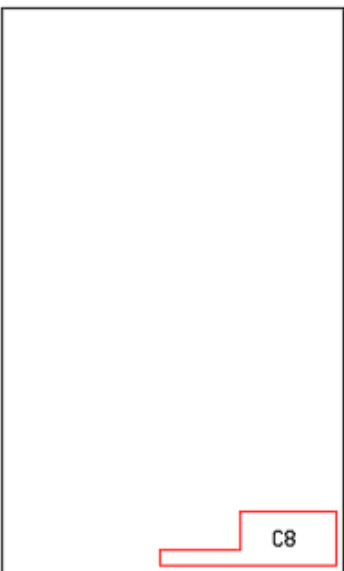
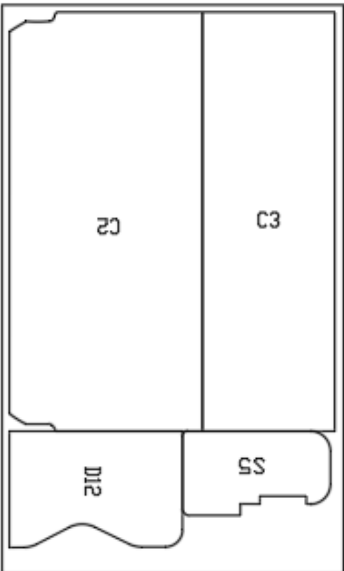
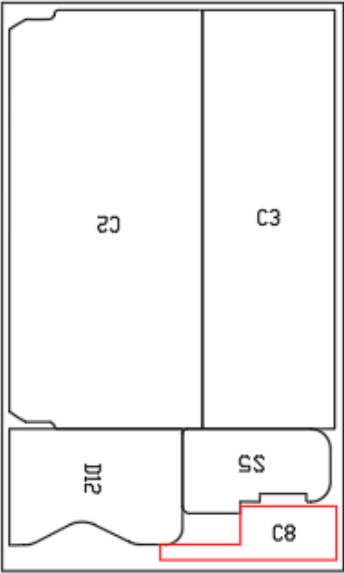
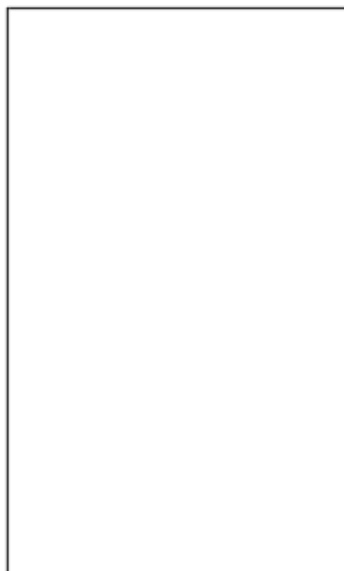
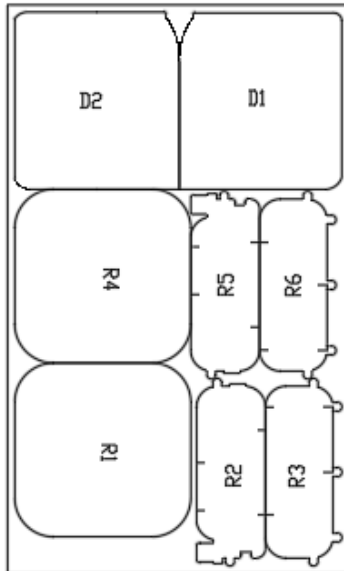
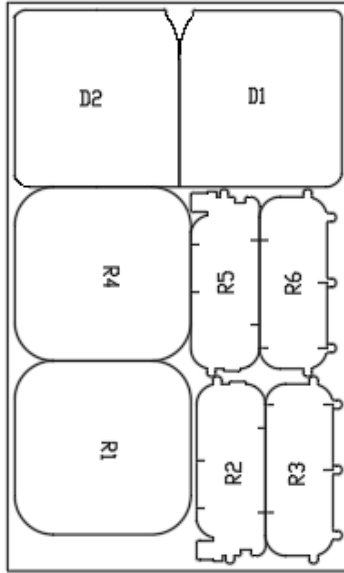
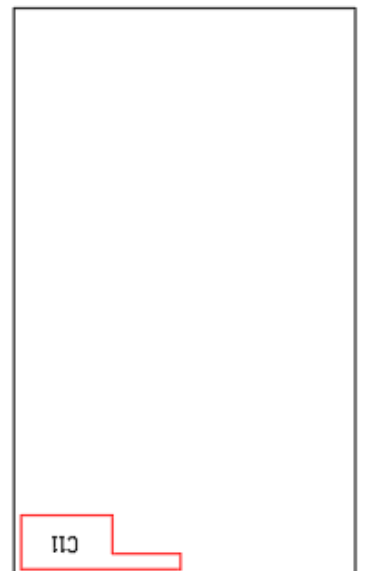
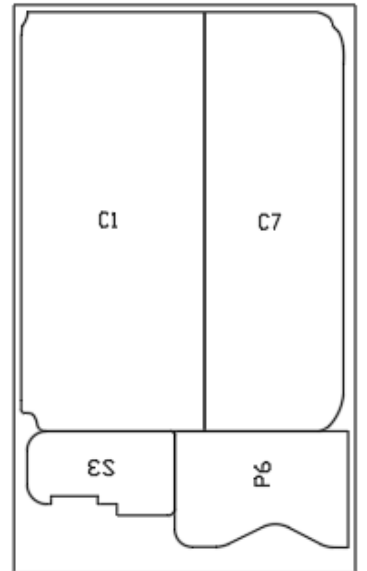
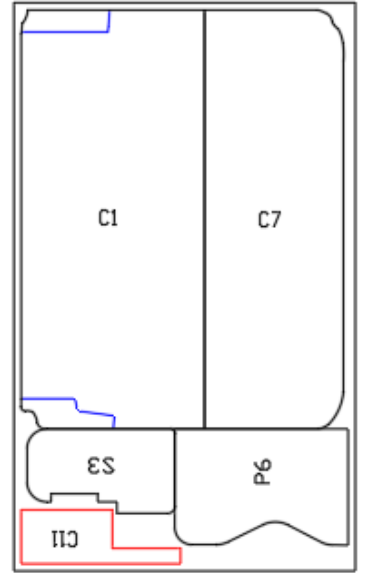

Panel Legend

D – Driver Side Wall	R – Rear Door
P – Passenger Side Wall	S – Sliding Door
W – Applicable to D/P/C	C – Ceiling

Please note that the sheet layouts are designed to accommodate all vehicle lengths and heights. Therefore, some sections will not be required for certain vehicles. Please refer to the sheet layout found above.

Sheet Layouts 4-6

FULL SHEET

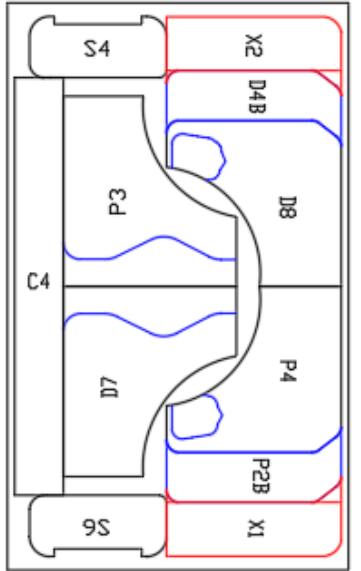

SECTIONS REQUIRED

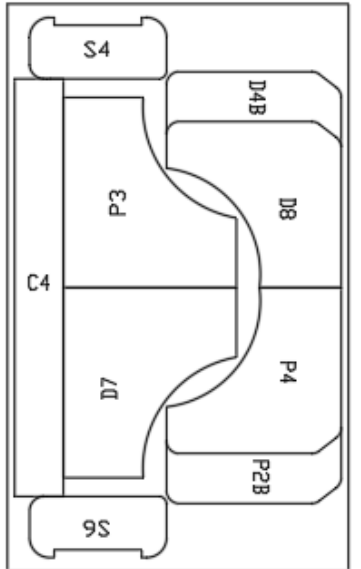

SECTIONS NOT REQUIRED

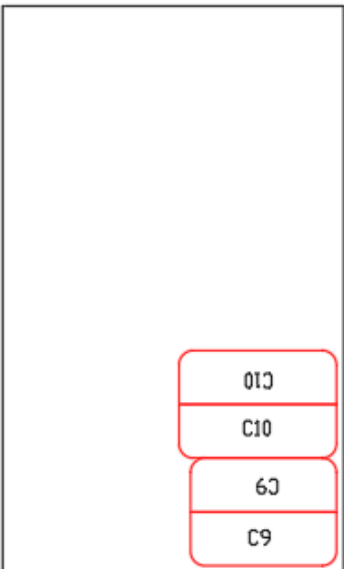
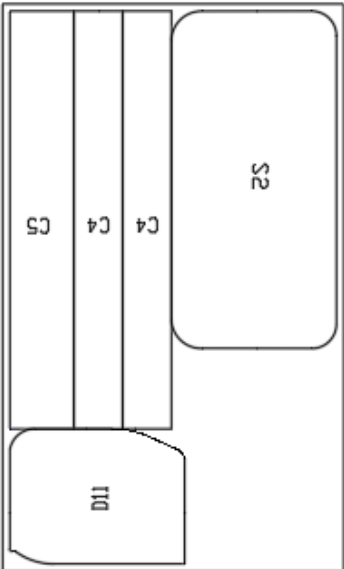
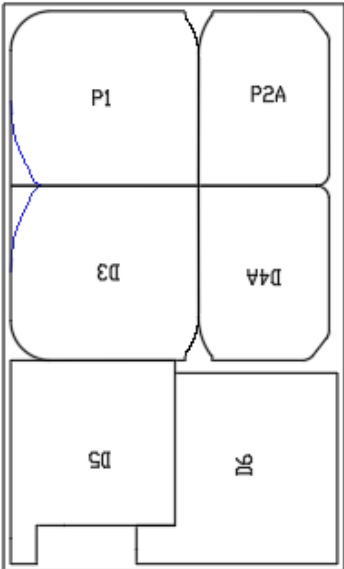
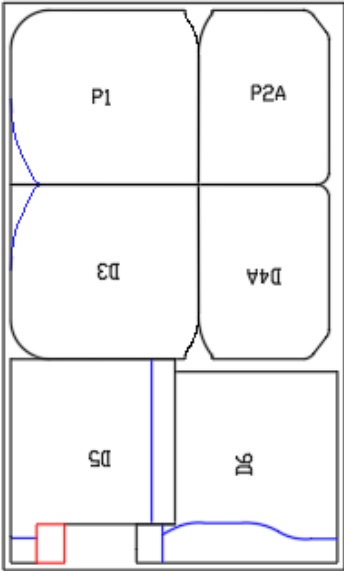
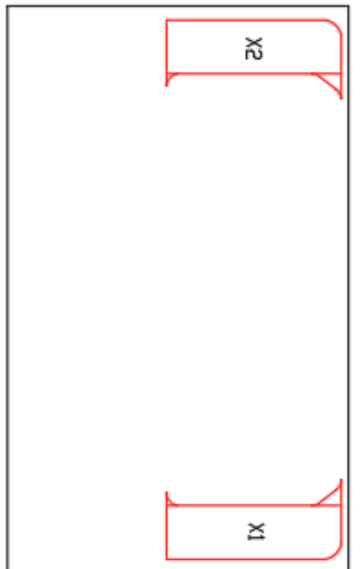

Panel Legend

D – Driver Side Wall	R – Rear Door
P – Passenger Side Wall	S – Sliding Door
W – Applicable to D/P/C	C – Ceiling

Please note that the sheet layouts are designed to accommodate all vehicle lengths and heights. Therefore, some sections will not be required for certain vehicles. Please refer to the sheet layout found above.

Sheet Layouts 7

FULL SHEET

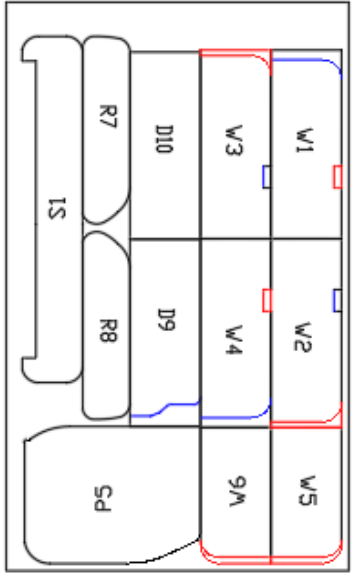

SECTIONS REQUIRED

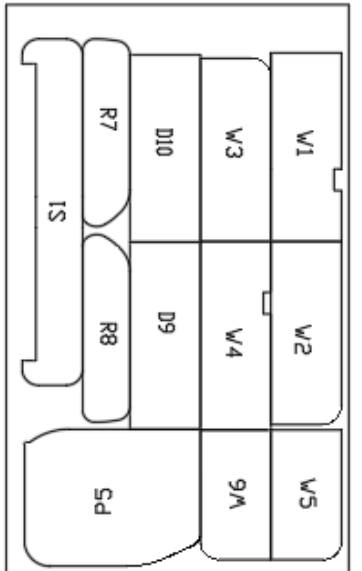

SECTIONS NOT REQUIRED

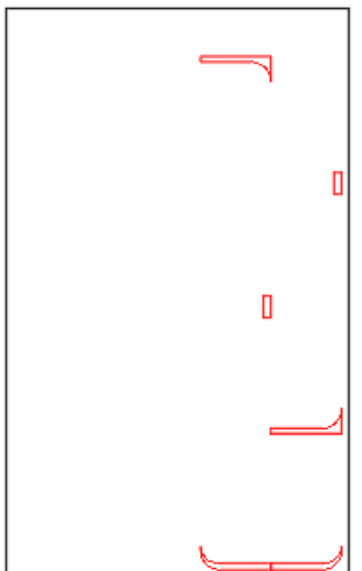

Panel Legend

D – Driver Side Wall	R – Rear Door
P – Passenger Side Wall	S – Sliding Door
W – Applicable to D/P/C	C – Ceiling

Please note that the sheet layouts are designed to accommodate all vehicle lengths and heights. Therefore, some sections will not be required for certain vehicles. Please refer to the sheet layout found above.

Assembly Instructions

Step 1: Identify the sheet you currently have as well as the TempShield panels and their respective vehicle surfaces in the next few pages. For additional guidance, please refer to the *Sheet Layouts* found in the previous pages and the *Full Vehicle Kit Overview* in the last page of this document.

Step 2: Wipe the identified surfaces of the vehicle clean, dry, free of dust, debris, or any foreign materials before adhering the TempShield panels.

Step 3: Peel off the protective layer of the TempShield and place its adhesive side to the Van body.

Tips and Notes

- Install the kit one sheet at a time.
- Keep your work area clean. Have a waste bin on standby to throw away the adhesive backing.
- To accommodate all vehicle lengths and heights, some panels also contain perforated cuts within the full section cuts. Certain vehicles will require this to be removed or separated, and certain vehicles will not. You will notice that these perforated cuts are way harder to separate compared to the full panel section cuts.

For example, panel P1 has a perforated cut within the full panel section cut as shown:

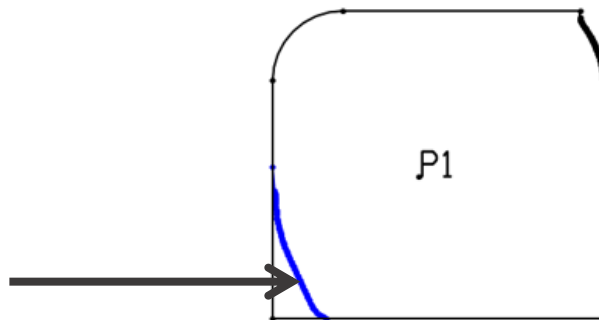

While the full sheet shows all the cuts on the sheet, these perforated cuts have been removed from the sections required column of the Sheet Layouts to clearly indicate which cut outline only needs to be removed for this specific vehicle. For example:

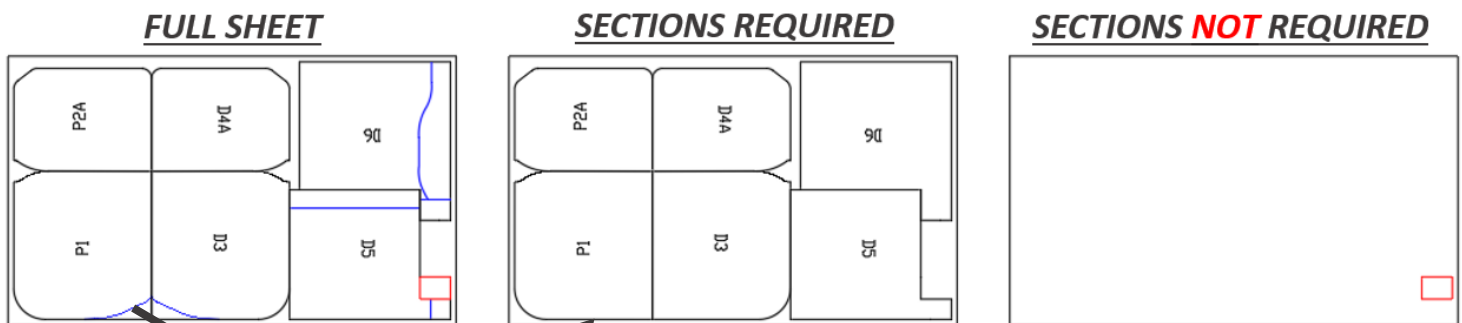

In this case, the image above indicates that the perforated cut of P1 does **NOT** need to be removed.

Sheet 1

FULL SHEET

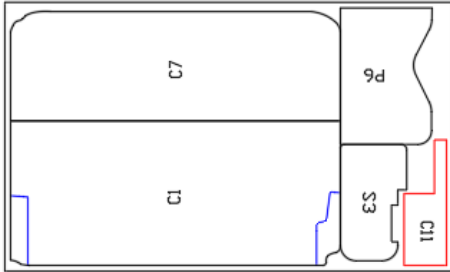

SECTIONS REQUIRED

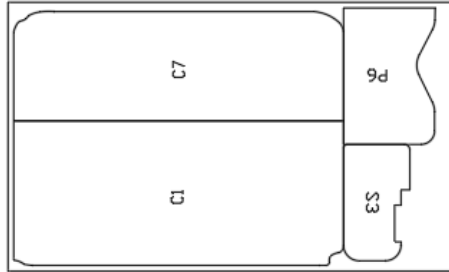

SECTIONS NOT REQUIRED

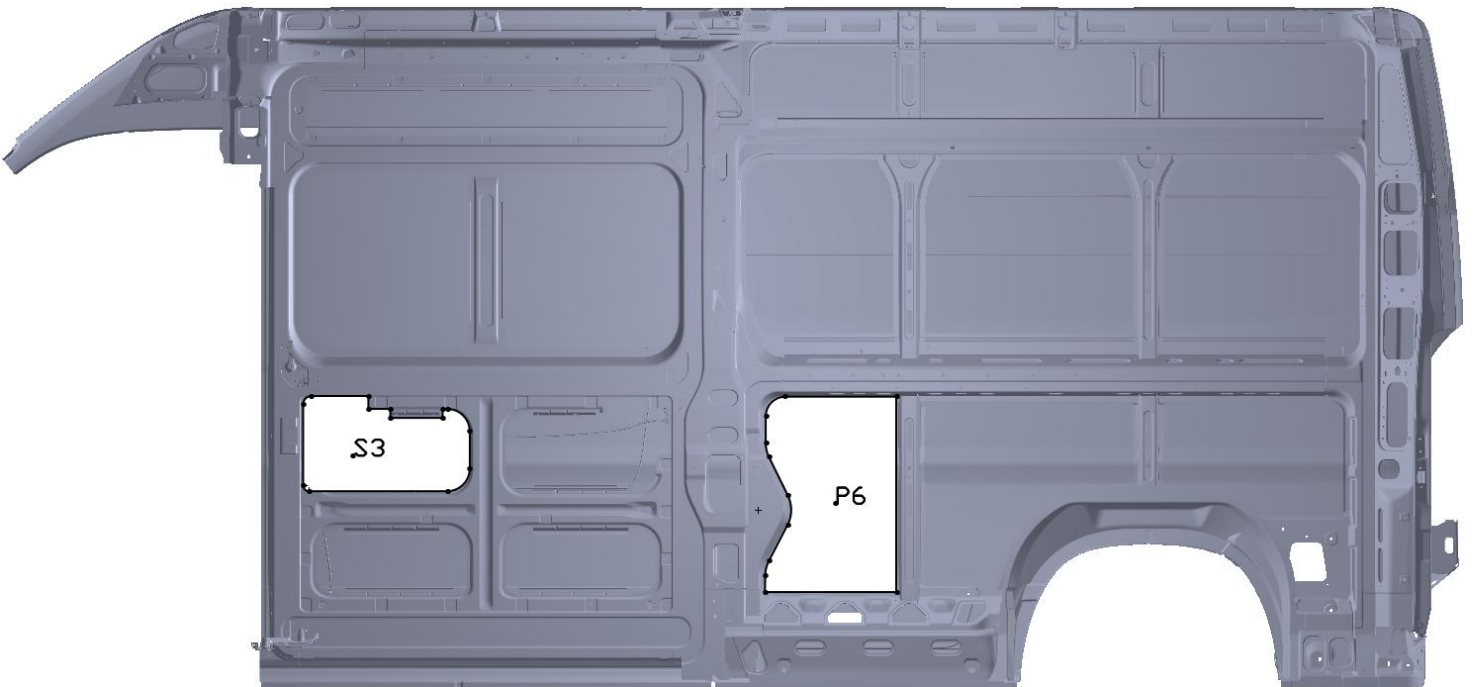
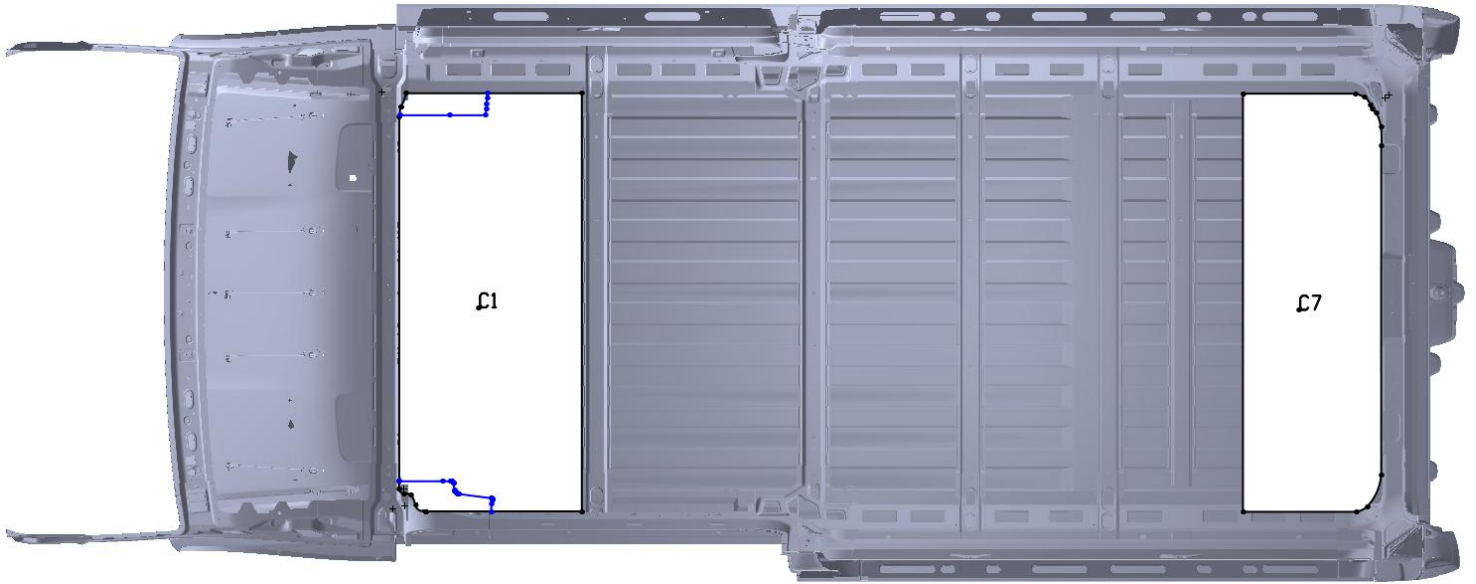

Sheet 2

FULL SHEET

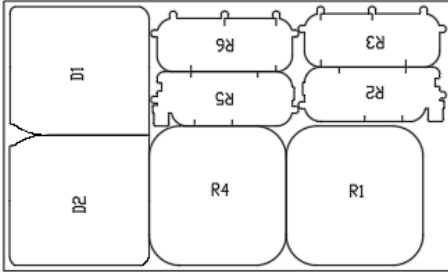

SECTIONS REQUIRED

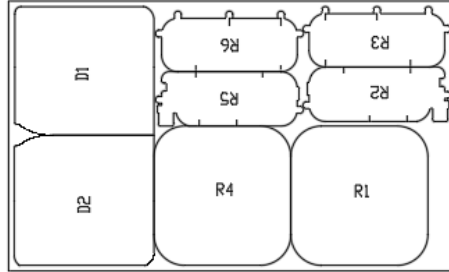

SECTIONS NOT REQUIRED

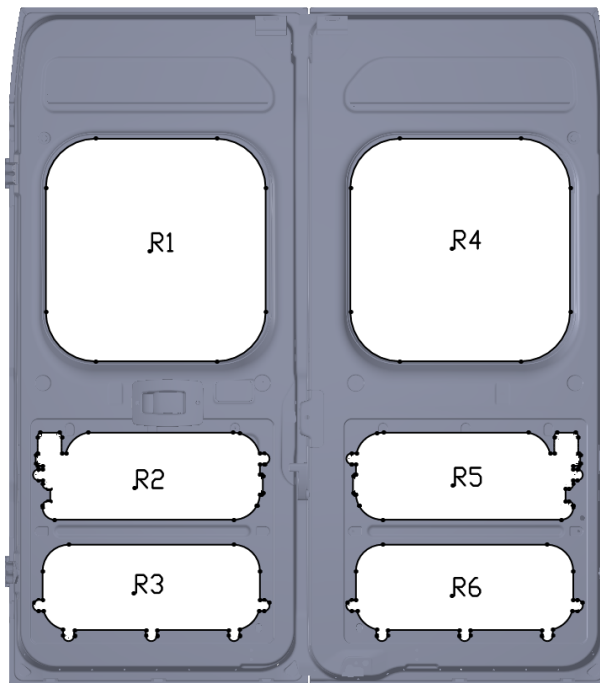
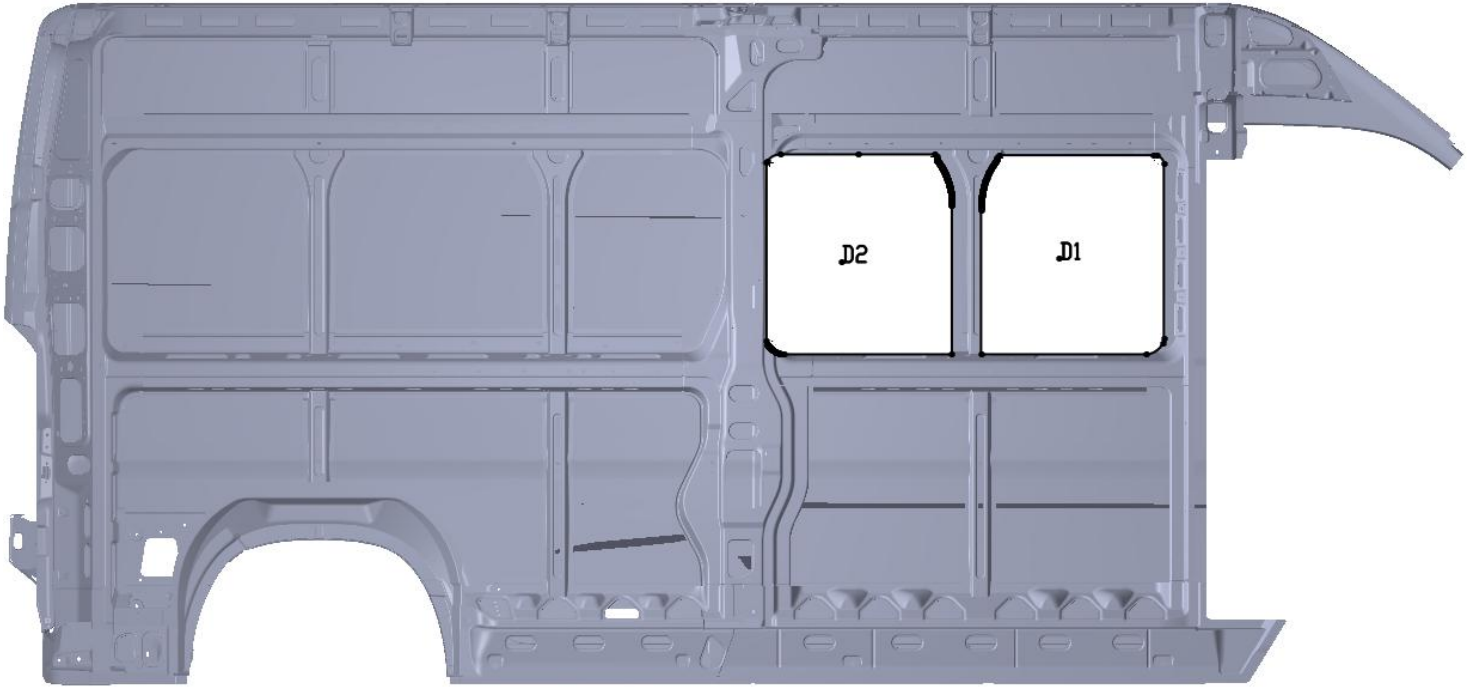

Sheet 3

FULL SHEET

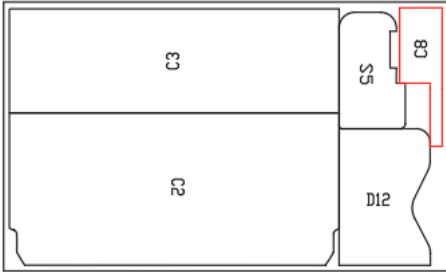

SECTIONS REQUIRED

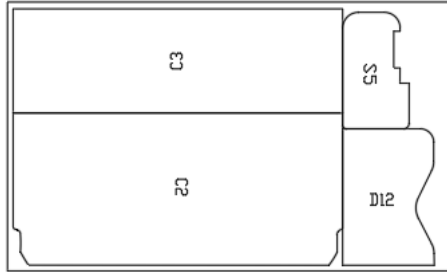

SECTIONS NOT REQUIRED

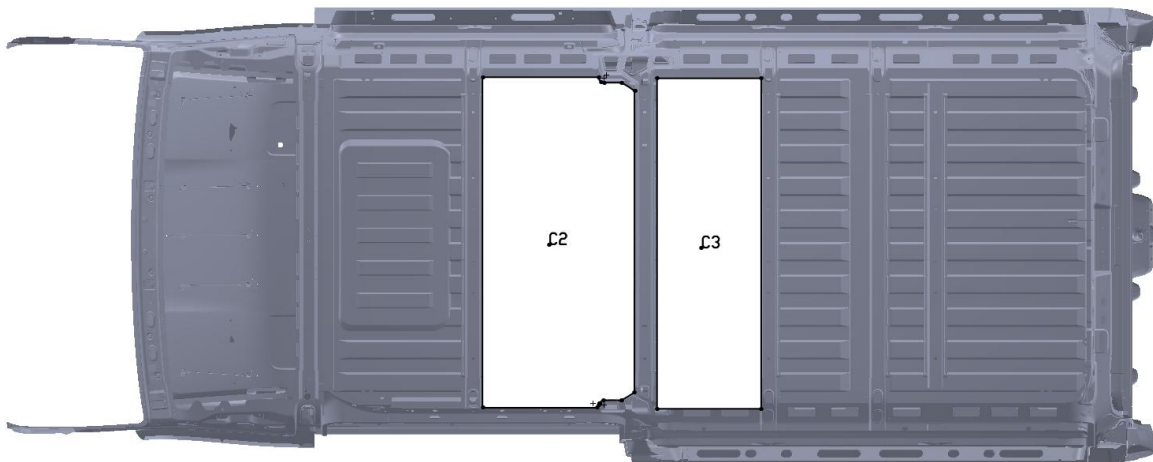
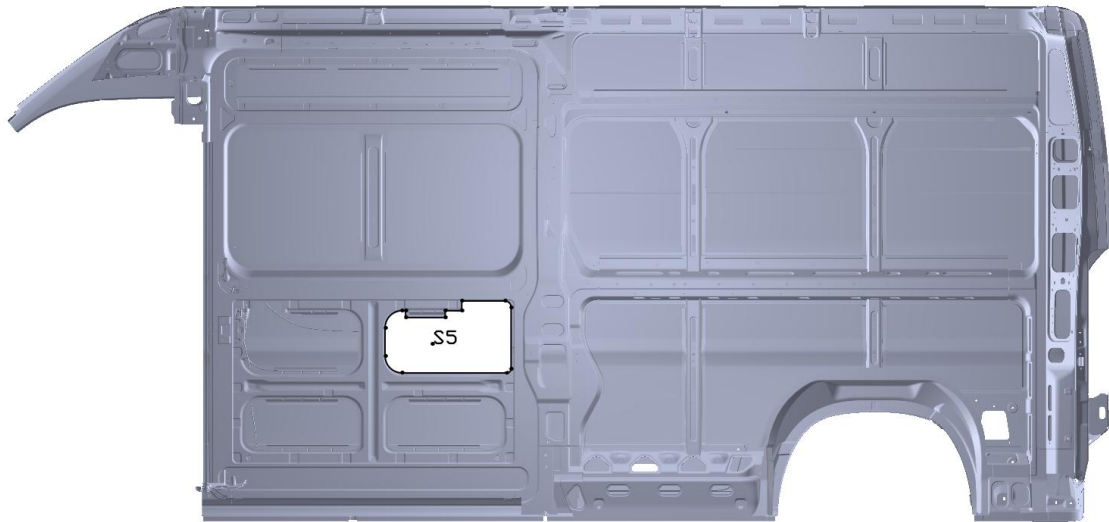
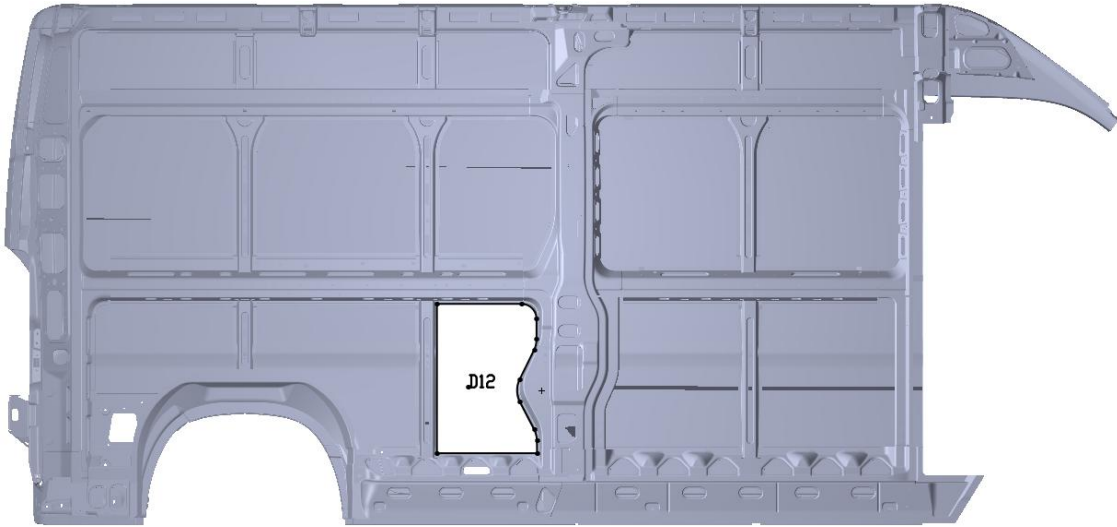

Sheet 4

FULL SHEET

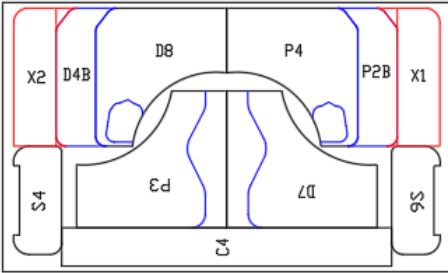

SECTIONS REQUIRED

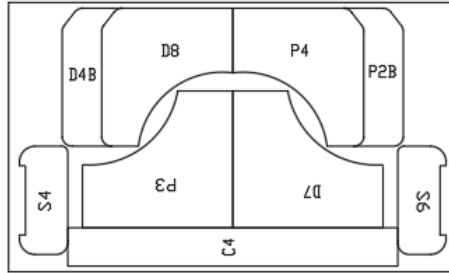

SECTIONS NOT REQUIRED

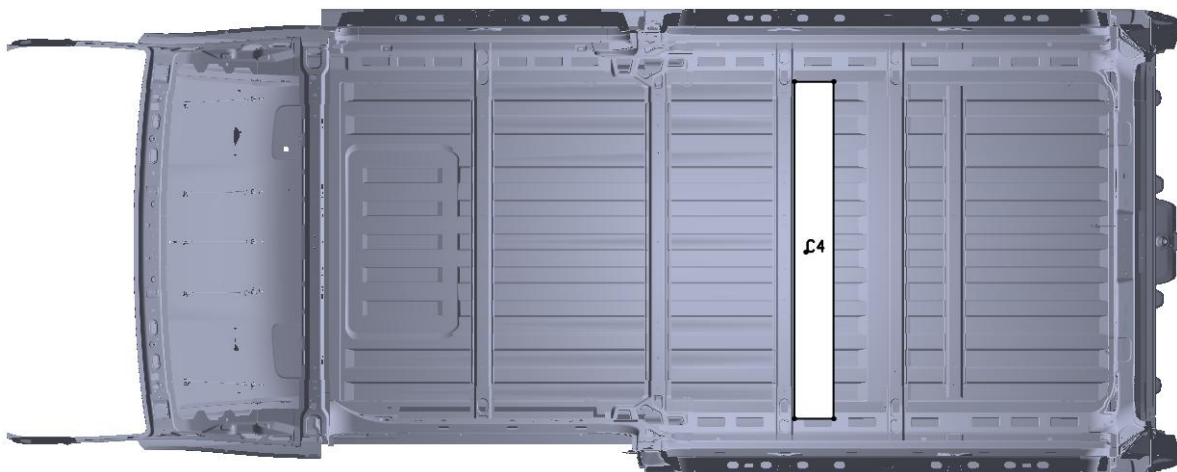
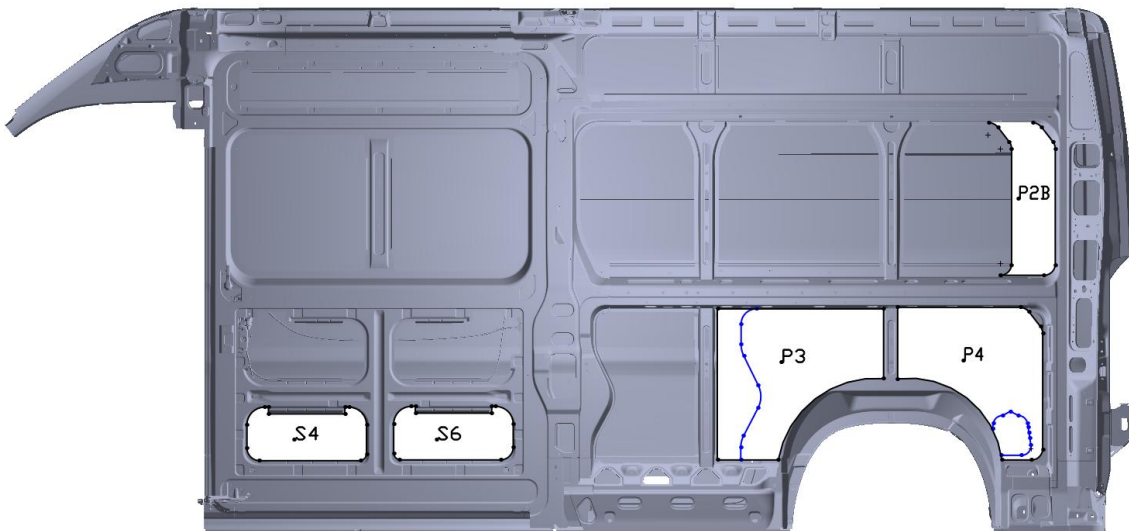
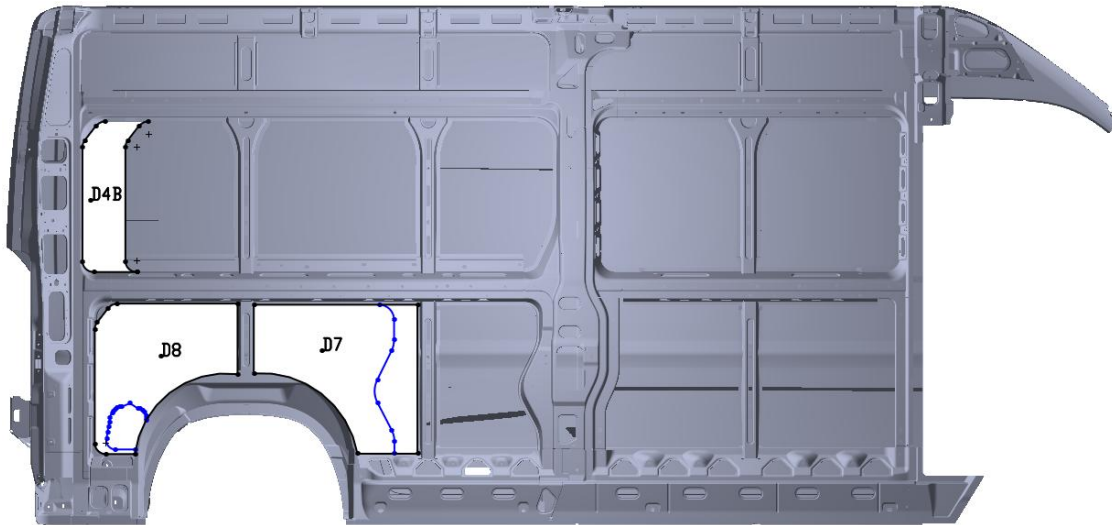

Sheet 5

FULL SHEET

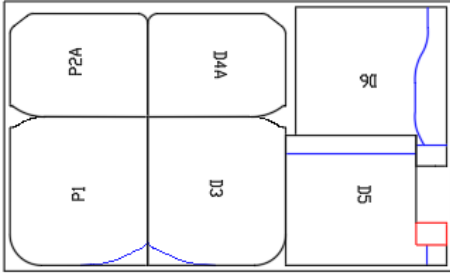

SECTIONS REQUIRED

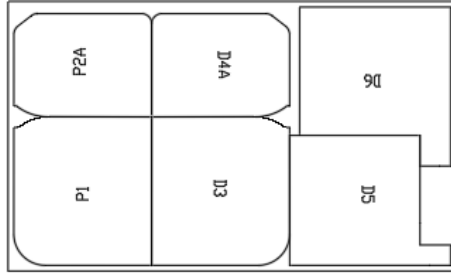

SECTIONS NOT REQUIRED

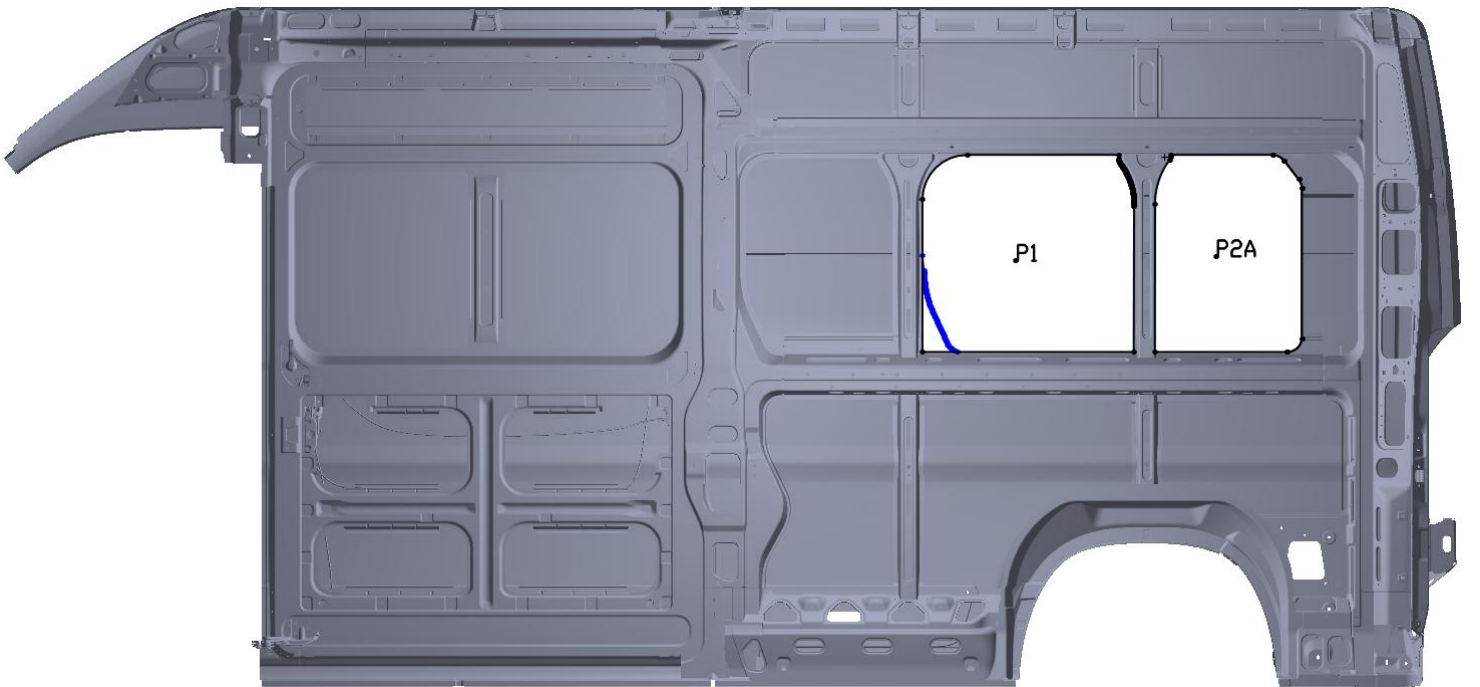
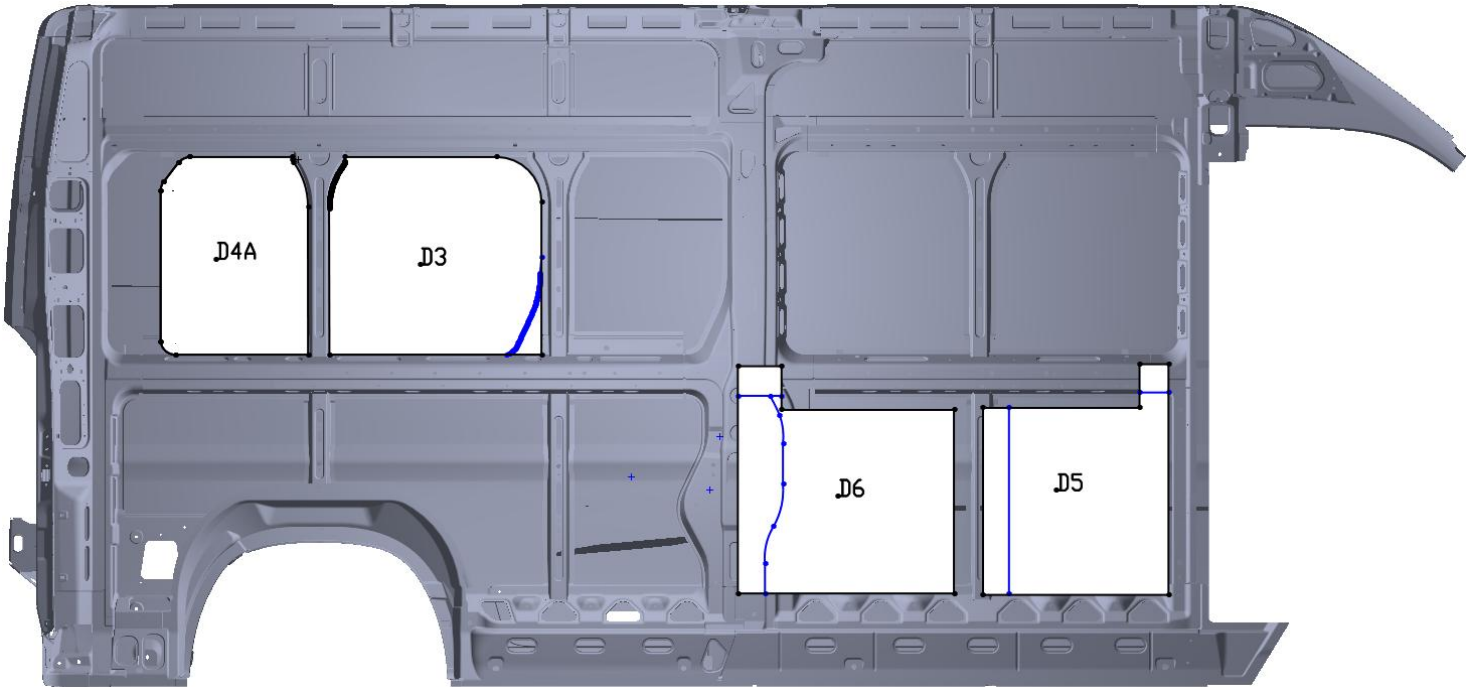

Sheet 6

FULL SHEET

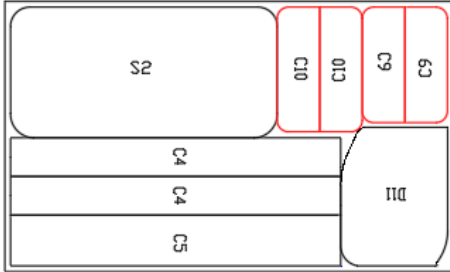

SECTIONS REQUIRED

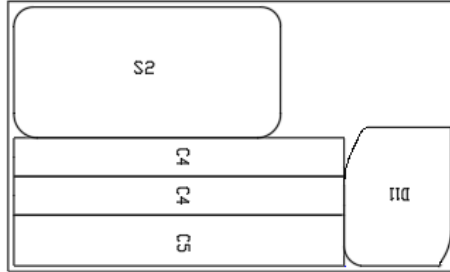

SECTIONS NOT REQUIRED

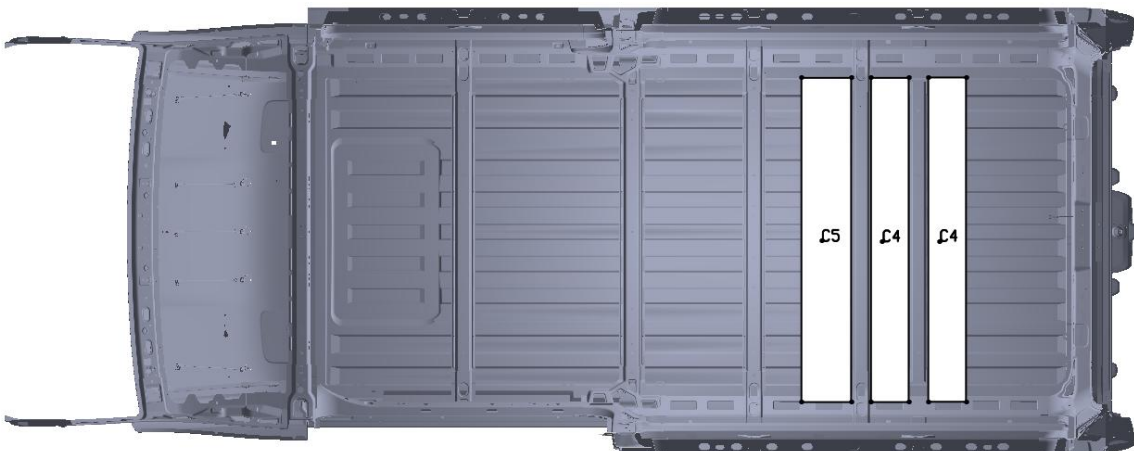
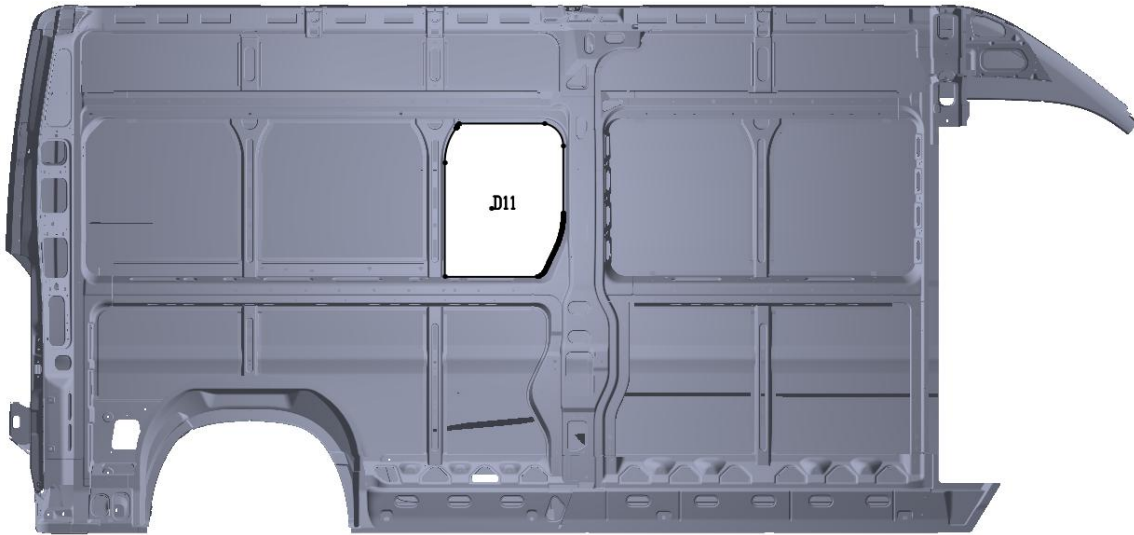
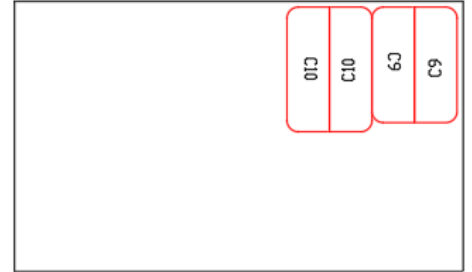

Sheet 7

FULL SHEET

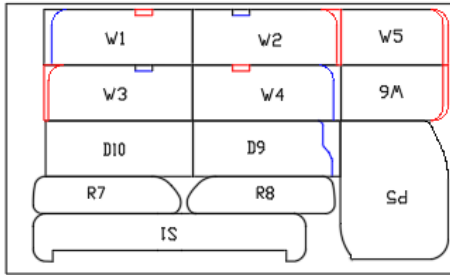

SECTIONS REQUIRED

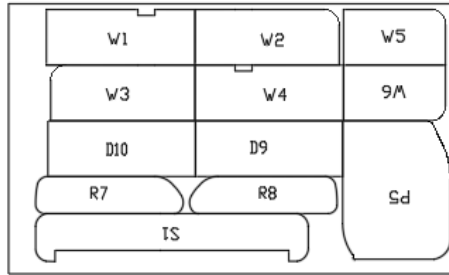

SECTIONS NOT REQUIRED

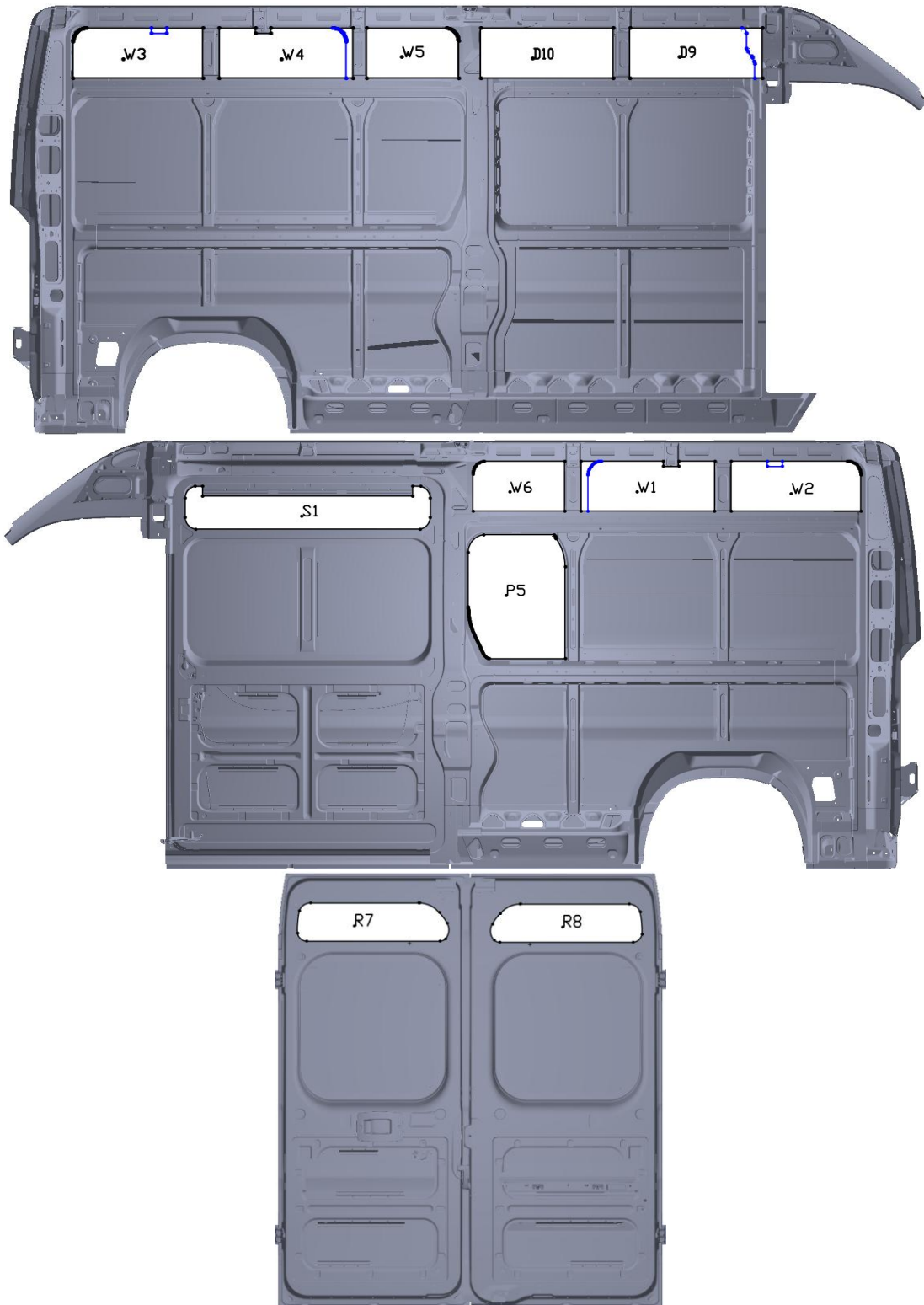
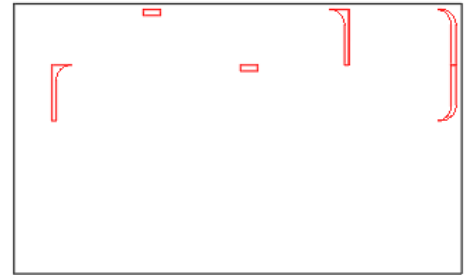



Installation Complete!

RAM ProMaster 159"

Cargo - High Roof

For more additional guidance, please refer to the last page which displays all the walls, doors, and ceiling panels installed in the vehicle.

TempShield Kit Overview

